



High Precision Rotation Luminaire Goniospectroradiometer (LSG-1890BCCD / LSG-1800ACCD)

Brochure

Global Office of Lisun Electronics Inc.

<http://www.Lisungroup.com>

Lisun Group (Hong Kong) Limited

Add: Room 803, Chevalier House, 45-51 Chatham Road South, Tsim Sha Tsui, KL, HK

Tel: 00852-68852050 Fax: 00852-30785638

Email: SalesHK@Lisungroup.com

Lisun Electronics (Shanghai) Co., Ltd

Add: 113-114, No. 1 Building, Nanxiang Zhidi Industry Park, No. 1101, Huyi Road, Jiading District, Shanghai, 201802, China

Tel: +86(21)5108 3341 Fax: +86(21)5108 3342

Email: SalesSH@Lisungroup.com

Lisun Electronics Inc. (USA)

Add: 445 S. Figueroa Street, Los Angeles, CA 90071, U.S.A.

Email: Sales@Lisungroup.com

Lisun China Factory

Add: NO. 37, Xiangyuan Road, Hangzhou City, Zhejiang Province, China

Tel: +86-189-1799-6096

Email: Engineering@Lisungroup.com

Leader in Lighting & Electrical Test Instruments

Rev. 4/28/2021

System Configuration

A. Goniophotometric System:

- Goniometric Rotating Console:
 - 1) LSG-1890BCCD: Japanese Mitsubishi Motor and German Angle encoder System to keep the test accuracy to 0.1degree
 - 2) LSG-1800ACCD: Taiwan Motor and Angle encoder System to keep the test accuracy to 0.2degree
- The LSG-1890BCCD has Goniometric Rotating Control Instrument in 19inch cabinet: It connects to the PC and was controlled by the software.
- The LSG-1890BCCD/LSG-1800ACCD has Goniometric Rotating Control Android App which can control it to rotate angle in the dark room easily.
- High Precision Photometer with Class A Constant Temperature Photo Detector (Option is Class L)
- Cross-beam Laser System for Calibrating
- English Measuring Software
- Three sets of luminaries Clamps: multi-functions
- Oversea Delivery and Packing: all of the instruments and accessories will be packed with Fumigation free three plywood, include the delivery cost to Shanghai sea port

B. SLS-150W DC Standard Light Intensity Lamp

C. Digital Power Meter:

- 1) LSG-1890BCCD has LS2050B Digital Power Meter: With LCD screen display, it is used to test AC/DC voltage, current, power, PF, DF and Harmonic
- 2) LSG-1800ACCD has LS2012 Digital Power Meter: It is used to test AC/DC voltage, current, power and PF

D. DC3010 CC & CV DC Power Source: DC3010 output is 30V/10A, Option can be DC6010 (output is 60V/10A) and DC12010 (output is 120V/10A)

E. AC Power Source: LSP-500V ARC Pure Sine Wave AC Power Source with LCD Screen: 500VA Output. It can communicate with PC via software

F. CASE-19IN 19inch Standard Instruments Cabinet.

G. LMS-9000CG High Precision CCD Spectroradiometer

H. CLAMP-9000 Accessories and Adjustable Tripod for LMS-9000CG

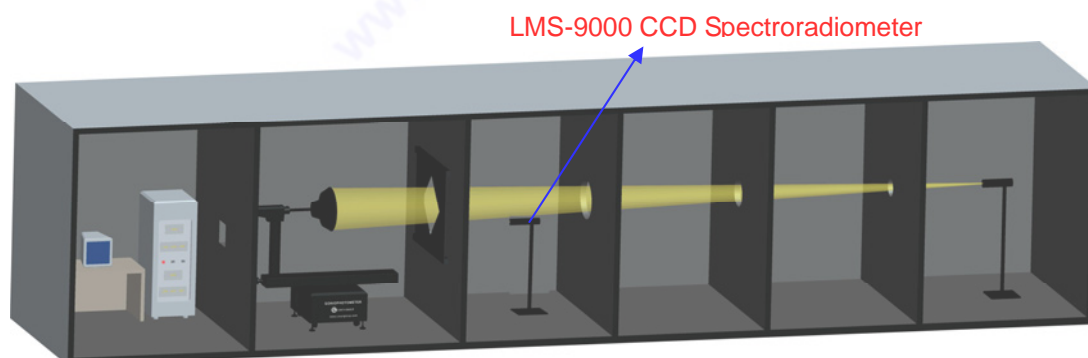

Note: PC and Printer prepared by the customer (request at least two USB ports)

2. Working Principle

Goniophotometric System carries out measuring methods of fixed location and rotating luminaries. The measured luminaries is installed on the rotating supported, the center of which is in line with the rotating supporter center with the help of Laser sight. The fixed photometry detector is testing the luminous intensity in various horizontal directions, while the light source rotating. The mechanical equipment allows turning the tested luminaries around a vertical axis and a horizontal axis. When the luminaries under test turn around horizontal axis, the detector which is at the same level with rotating table will measure the intensity of each direction at this surface. When rotating with vertical axis, the detector will measure the intensity at the vertical surface. The vertical and horizontal axis can be rotated continuously at $-180^{\circ} \sim +180^{\circ}$. According to the measurement requirements, the system can be operated in B- β , A- α and C- γ coordinates. When getting intensity distribution data, computer will calculate other photometric parameters automatically.

Double pillars structure (B- β , A- α coordinate system)

This type is applied to fixed grille lamp. The symmetry axis of lamp and the horizontal of rotating supporter is coaxial in the B- β coordinate system, and the two is vertical Cross in the A- α coordinate system.

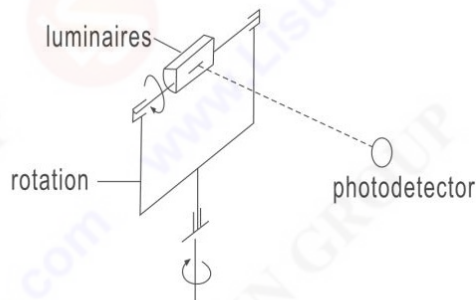
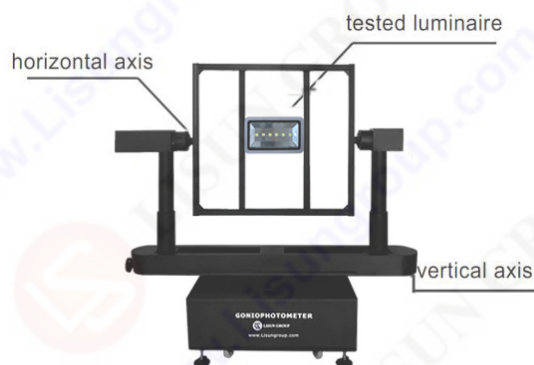

Double pillars structure

Single pillar structure (C- γ coordinate and Conic coordinate)

The single column structure will be gotten when the assistant column is taken down from double columns structure. This type is applied to fixed tube lamp, spot lamp etc. The axis radiation of lamp and the horizontal of rotating supporter is coaxial.

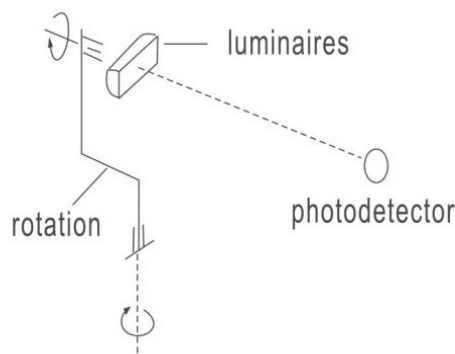

3. System Functions

LSG-1890BCCD/LSG-1800ACCD Goniophotometer is high precision automatic goniophotometric instrument for luminous intensity distribution measurements with facility for turning the light source. [The LSG-1890BCCD uses a constant temperature detector, Japanese Motor and Germany precision angle coder which keep high test accuracy.](#) It is for industrial laboratory measurements the photometric data of luminaries.



Be utilized to measure photometric parameters of luminaries for LED road lighting fixture, room lighting fixture and projecting lighting fixture, such as spatial intensity distribution curve, spatial iso-intensity curve, intensity distribution curve on each section (represent by right-angled coordinates or polar coordinates, luminance limitation curve, luminaries efficiency, glare grade, effective beam angle, upward luminous flux ratio, downward luminous flux ratio, total luminous flux, effective luminous flux, utilization factor and electric parameters voltage, current, wattage, power factor and etc. The measured data meets IES standard format and can be applied for lighting design by lighting design software. The measurement system fully satisfies the requirement of lighting design work.

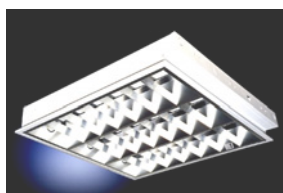

4. Specifications

- Meets the requirements of CIE, IEC, IES LM-79 & GB standards
- The Goniospectroradiometer system=Goniophotometer+Spectroradiometer Integrating Sphere system
- Test Max Luminaires size and weight: LSG-1890BCCD is 1900mm/60kg and LSG-1800ACCD is 1600mm/50kg
- The tested luminaires rotates around an angle of $(\gamma)\pm 180^\circ$ (or 0-360°) and the tested luminaires rotates around itself with an angle of $(C)\pm 180^\circ$ (or 0-360°)
- Luminosity Testing Range: Illuminance 0.001lx~99,999lx; Light Intensity 1.0cd~ 10^7 cd(detector)
- Angle accuracy: LSG-1890BCCD is 0.1°, LSG-1800ACCD is 0.2°
- Work with high accuracy and quick CCD Spectroradiometer to measure spatial color parameters.
- Accuracy of chromaticity coordinate: ± 0.0015 or ± 0.0005 (under standard A lamp)
- Spectral Range Wavelength: 350nm ~800nm; Accuracy of wavelength: ± 0.5 nm
- The Hardware and Software can do the PAR, PPF and PPFD 3D distribution test, which can export IES/LDT files.
- Photometry Accuracy: CIE Class A (Class L is option)
- Testing Accuracy: 2%(Under Standard lamp); Stray Light: less than 0.1%
- English version software can run in Win7, Win8 or Win10

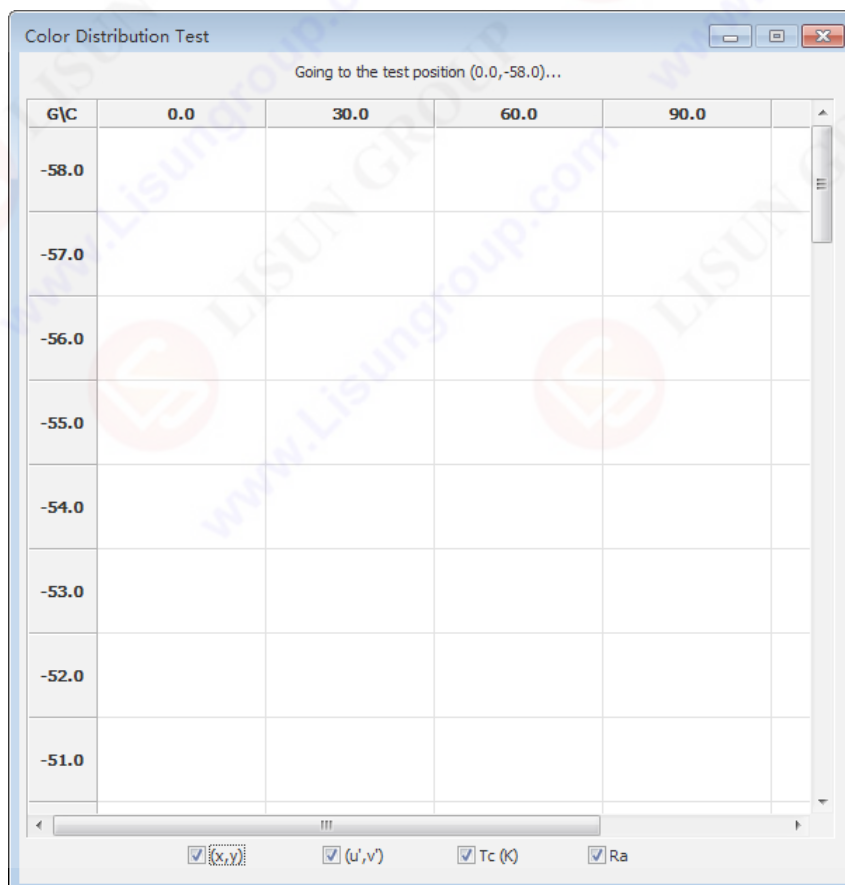

5. Laboratory Requirements

LISUN MODEL	Center Height (A)	Total Height (B)	Total Depth(C)	Total Width(D)	The max size for the Testing Lamp(Unit: mm)		The max diameter of the mast rotating (G)	Max Testing Weight
					C-Gamma Test with one Pillar (Diameter E* Depth F)	B-Beta Test with two Pillars (Length*Width)		
LSG-1890BCCD	1510	1600	922	1750	∅1900x550	600*600	∅2000	60kg
LSG-1800ACCD	1370	1420	750	1650	∅1600x550	600*600	∅1700	50kg

Table 1 The Dimensions of the Goniospectroradiometer Master

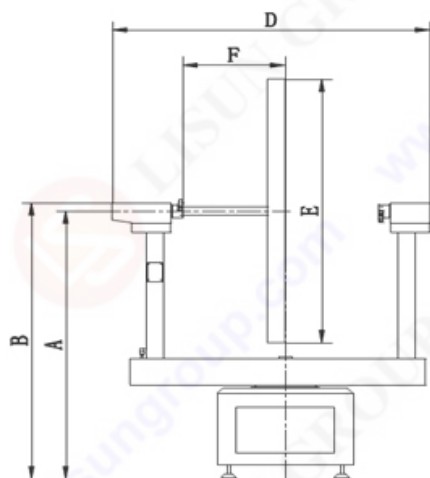

Figure 1 The Side View

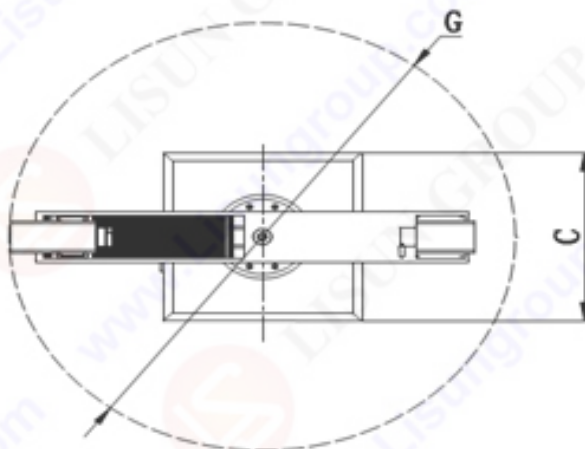
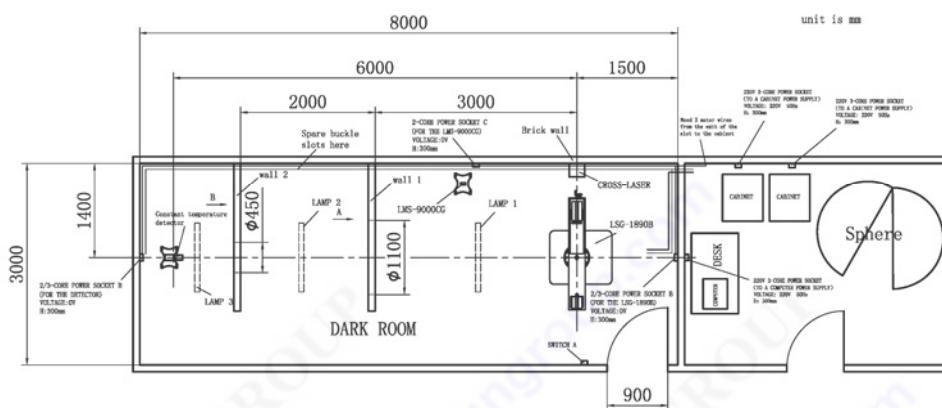

Figure 2 The Vertical View

- Dark Room size request (The G, A and E please refer to the above table 1 and figure 1 and 2): The darkroom Width $W=G+X$ (It recommends the X is min 500mm which can allow one person pass). The darkroom Height $H=A+0.5*E+Y$ (It recommends the Y is min 100mm to the ceiling). The darkroom Length $L=6*E$ (According to CIE, it requests at least 6times than the testing lamps).
- Control Room size request: min=2000*2000*2000mm
- The wall, ceiling and floor should be all coated with dull black paint or be covered by black cloth and black carpet.
- Air-conditioner should be set in the dark room to control the temperature around lamps to the standard value upon the CIE requirements
- LISUN engineer dept will submit the Lab Design support documents according to the customer’s lab size after the purchase order was confirmed (The below are two Typical Lab Design reference for LSG-1890BCCD/LSG-1800ACCD)

LSG-1890BCCD DARK ROOM VERTICAL VIEW



Technical requirements:

1. The walls and ceiling of the darkroom need to be painted matte black. Cover the floor with black carpet.
2. The wires for 3-core power socket A and 2/3-core power socket B are inside of the buckle slot from the cabinet. Need 2 meter wires from the exit of the slot to the cabinet. Another buckle slot at the same place for backup.
3. Switch A is for lamp 1, lamp 2 and lamp3. Lamps should be installed on the ceiling.
4. The 3-Core power socket for LSG-1890B must be well grounded or connected with the separate earthing terminal.
5. The dotted line buckle slot need to be easy tear open outfit and matte black.
6. The wall for cross laser is better to be brick. The cross laser together with the holder is about 5kg and need to be fixed on the wall.
7. Diameter of all wires are at least 2mm².
8. The air conditioner outlet must not close to the luminaries being measured or the light path.
9. The windows need to be blocked or covered by matte black curtain.
10. The width of dark room door above 900mm, so that LSG-1890B could enter into dark room.

LSG-1800ACCD DARK ROOM VERTICAL VIEW

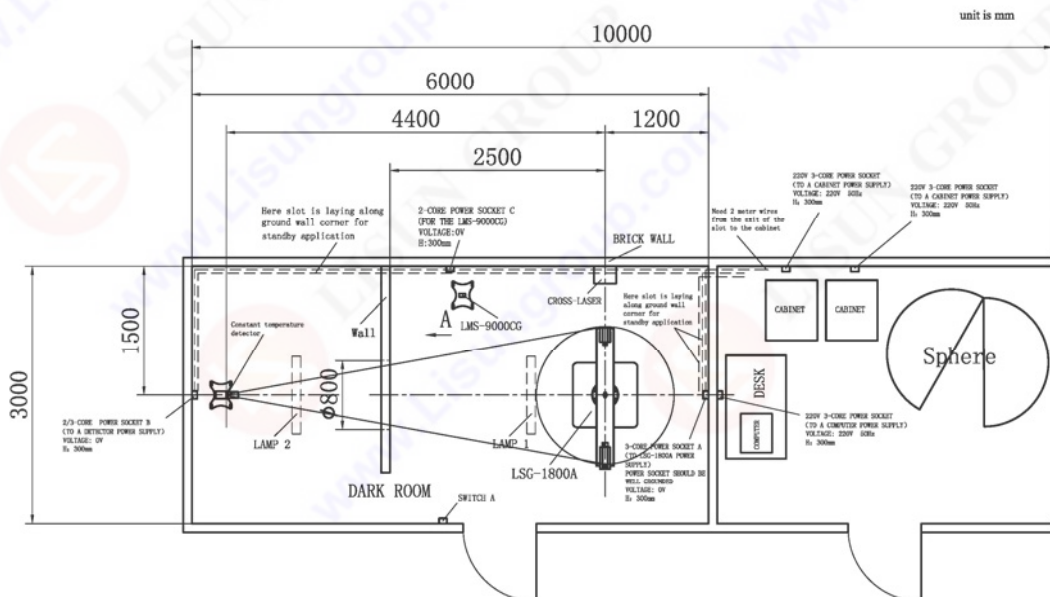

Technical requirement:

1. The walls, floors and ceilings of dark room must painted matt black paint and the ground spreads black carpet .
2. The power lines of three-core power socket A and two / three-core power socket B laying along the wall and into the operating room, requires power line head exposed ground 2 meter, the other slot laying along and enter into operating room for standby application.
3. SwitchA used to control lamp 1、 lamp 2 , Lamp installed in the ceiling.
4. Three-core power socket A (Power to LSG-1800A) must be well grounded, or separate ground terminal .
5. The slot where is referring by dotted line should be detachable, and the width of the slot should be not less than 50mm .
6. The wall to install cross laser must be brick wall.
7. The windows are sealed off in the darkroom to make sure light cannot leak absolutely.
8. In the dark room where LSG-1800A main machine placed ,the air outlet of air set should not directly face to the tested lamp and the optical path.
9. All wire diameter $\geq 2\text{mm}^2$.

6. Typical oversea market customers:

There are many world famous companies and lab institute choose Lisun Goniophotometer, Please get the reference customers' information from Lisun Group Oversea Sales Dept.

7. Design Standard of Device

The construction, technical parameter, test & operate steps as well as data processing software of goniophotometer meet the following requirements:

- CIE Pub. NO.70, "The Measurement of Absolute Luminous Intensity Distributions"
- CIE DIV. II -TC10, "Photometry of Luminaires"
- IES LM-35-1989, "IES Approved Method for Photometric Testing of Floodlights"
- IES LM-31, "IES Approved Method for Photometric Testing of Roadway Luminaires"
- IES-LM-79-19, "Electrical and Photometric Measurements of Solid-State Lighting Products"
- GB/T 7002-1986, "Luminosity Test of Flood Luminaires"
- GB/T 9467-1988, "Luminosity Test of Indoor Luminaires"
- GB/T 9468-1988, "Luminosity Test of Street Luminaires"
- IES 61341 "Method of Measurement of Center Beam Intensity and Beam Angle(s) of Reflector Lamp"
- CIE Pub.NO.76, "Photometry-the CIE System of Physical Photometry"

8. Application Software

All control of the goniophotometer operations can be realized by the software, including gonophotometer movement, data acquisition and processing, real-time display on screen, report print and etc, thus enabling the measurement easy and secure.

This system can export data files as following formats:

```
IESNA Files (*.ies)
EULUMDAT Files (*.ldt)
CIEBSE TM14 Files (*.cib)
CIEBSE TM14 Files (*.tm4)
CIE Files (*.cie)
DIN CEN Files (*.cen)
Excel File (*.csv)
```

This kind of format files can be transferred by other illumination and luminaries design software such as DiaLux

Application software can also implement essential calculation for lighting design as iso-illuminance distribution curve on a working plane, luminance limitation curve, luminary's efficiency, effective beam angle, upward luminous flux ratio, downward luminous flux ratio, effective luminous flux, utilization factor curve etc.

The Next Page is the Test Report by software

Report No.: 4

Test Time : 2021-03-09 16:28:41

Page 1 of 29

Lisun Goniophotometer Test Report

Product Info

 Luminaire Category : **Indoor LED**

 Lamp : **cree**

 Manufacturer : **Philips Lighting B.V.**

 Submitter : **Michael Aslami**

 Nuber of Lamps : **1**

 Lumens per Lamp : **2100 lm**

 Luminous Length : **100 mm**

 Luminous Width : **100 mm**

 Luminous Height : **0 mm**

Electric Parameters

 Voltage : **229.80 V** Current : **0.1320 A** Power : **28.56 W** Power Factor : **0.938** Frequency : **50.06 Hz**

Photometric Parameters

 CIE Class : **Direct**

 Measurement Flux : **1942.7 lm**

 Upward Ratio : **6.67 %**

 Maximum Intensity : **663.61 cd**

 Central Intensity : **663.51 cd**

 Luminaire Efficacy Rating (LER) : **68**

 Beam Angle (C0-C180,C90-C270) : **117.9 °, 115.4 °**

 Field Angle (C0-C180,C90-C270) : **155.6 °, 153.1 °**

 Total Rated Lamp Lumens : **2100.0 lm**

 Efficiency : **92.51 %**

 Downward Ratio : **85.84 %**

 Position Of Maximum Intensity : **C60° γ1°**

 S/MH(C0-C180,C90-C270) : **1.32, 1.30**

 Energy Efficiency Class : **A (EU 874/2012 EEI:0.247)**

 Beam Angle (C45-C225,C135-C315) : **117.2 °, 117.2 °**

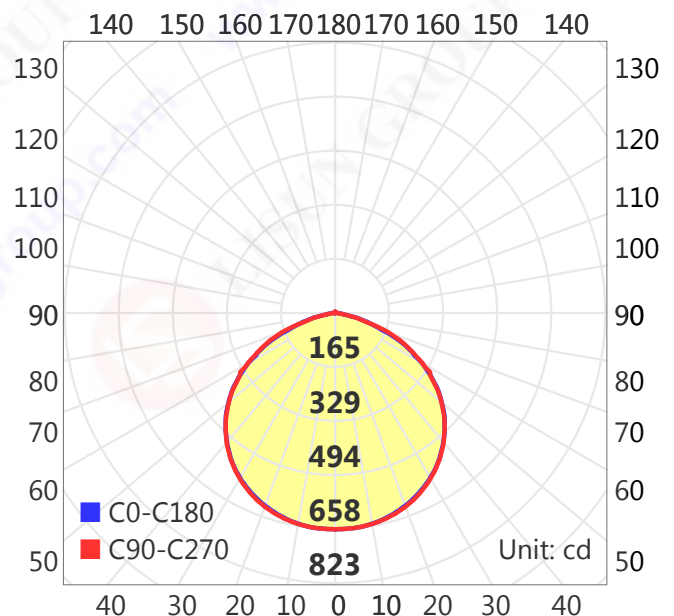
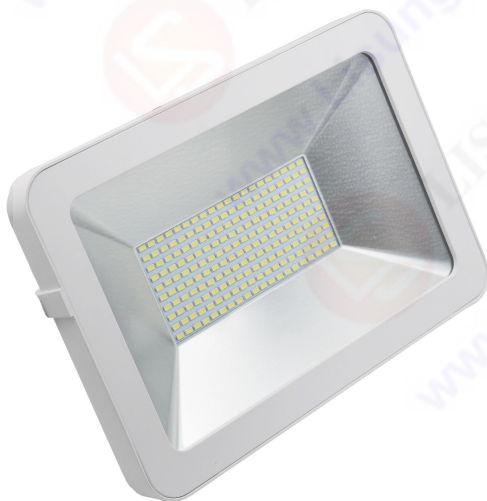
 Field Angle (C45-C225,C135-C315) : **155.0 °, 155.0 °**

Average Beam Angle (50%): 116.8°

 Test Type : Type C Test Distance : 8.160 m
 Test Device : Lisun LSG-1890B (E312012J)
 Test Lab : LISUN Lab
 Test By : David

 C Plane (°): 0.0-180.0:1.0 γ (°): 0.0-180.0:1.0
 Temperature : 25.0°C Humidity : 65.0%

Review By :

Light Distribution Curve

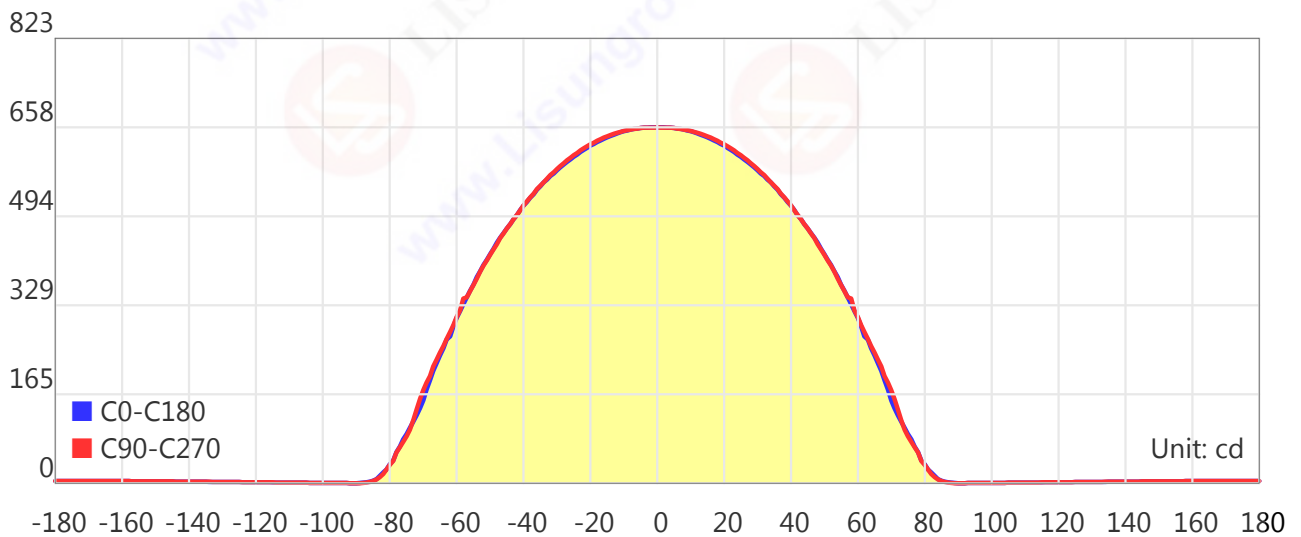
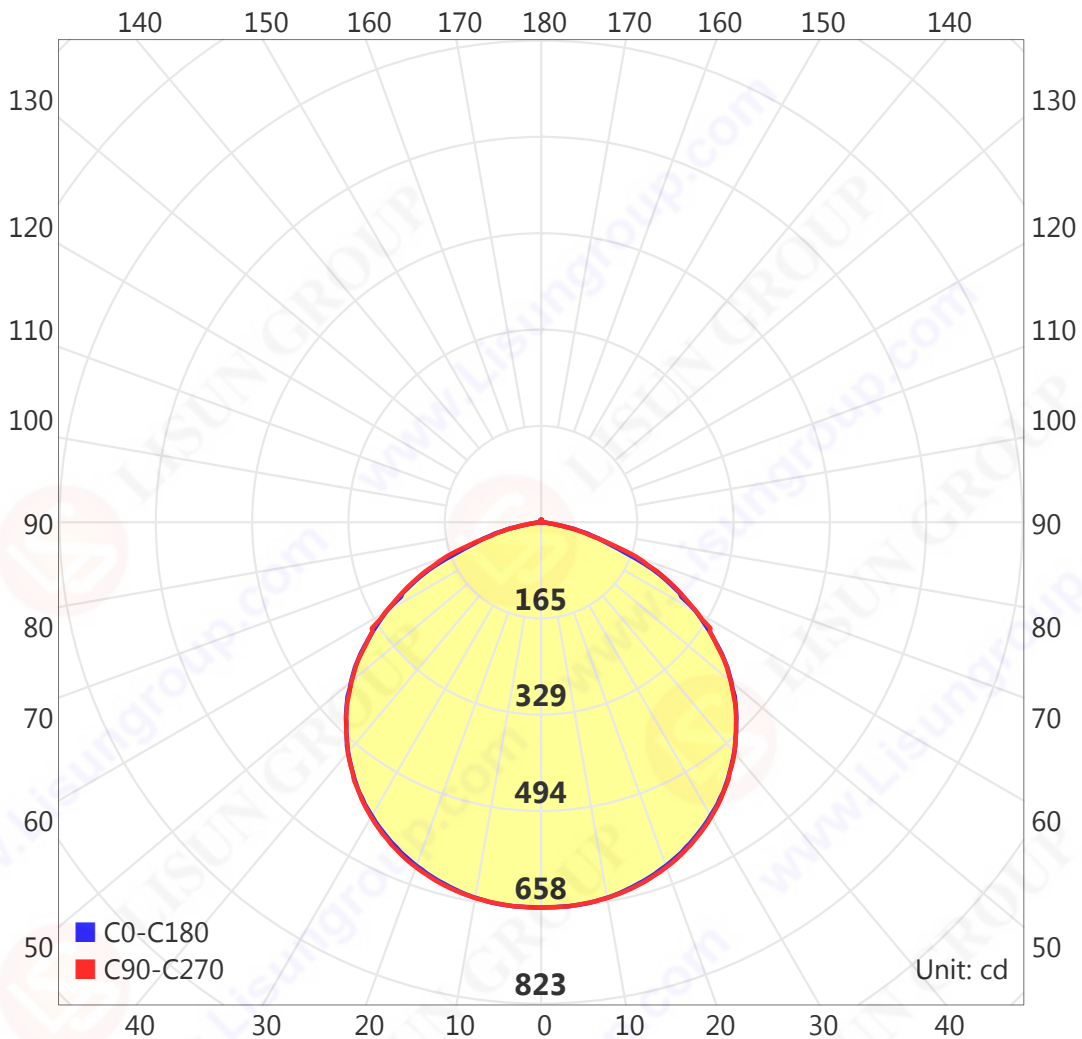

Light Distribution Curve (cd/klm)

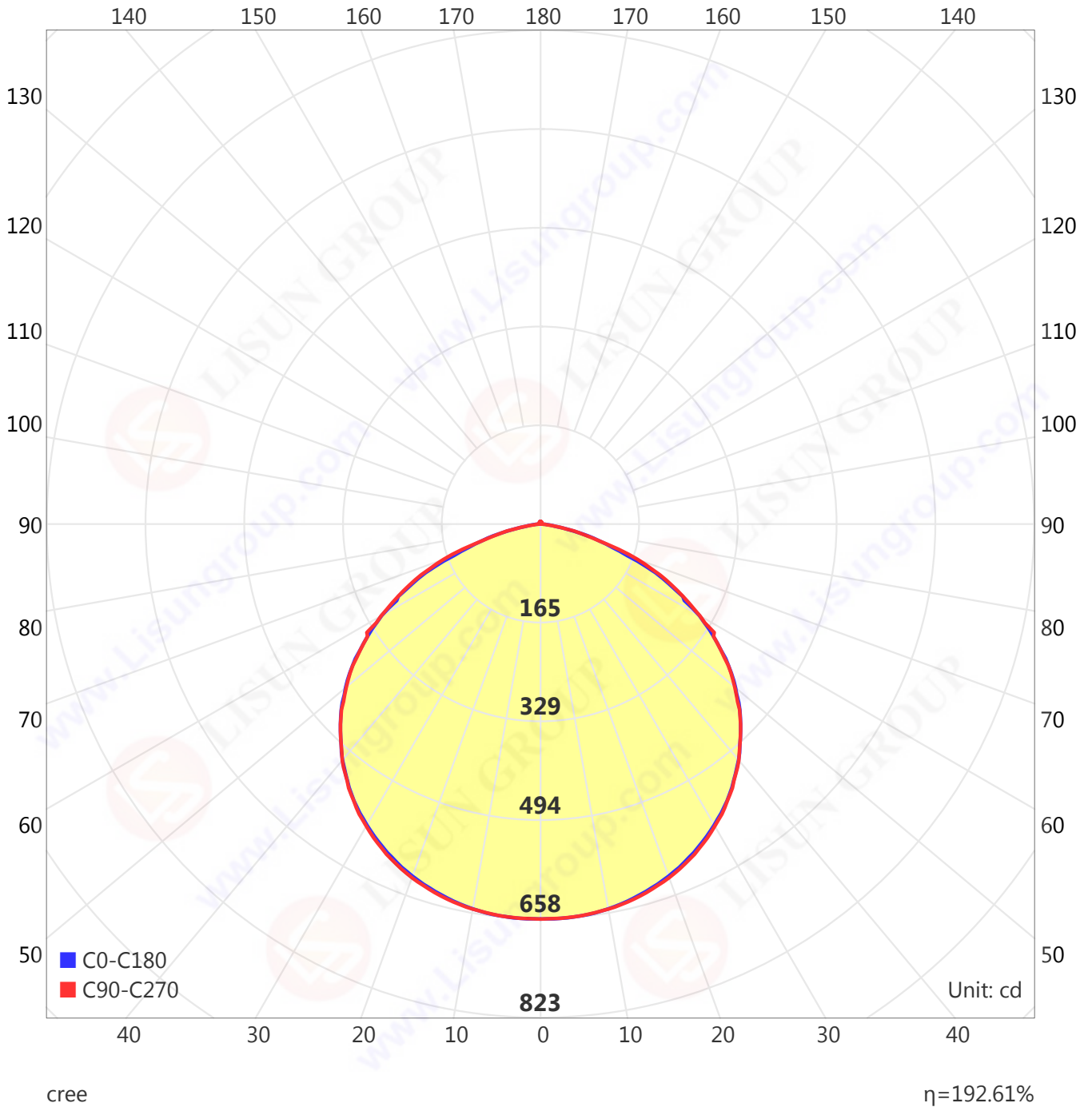

Report No.: 4

Test Time : 2021-03-09 16:28:41

Page 4 of 29

Warmup Log

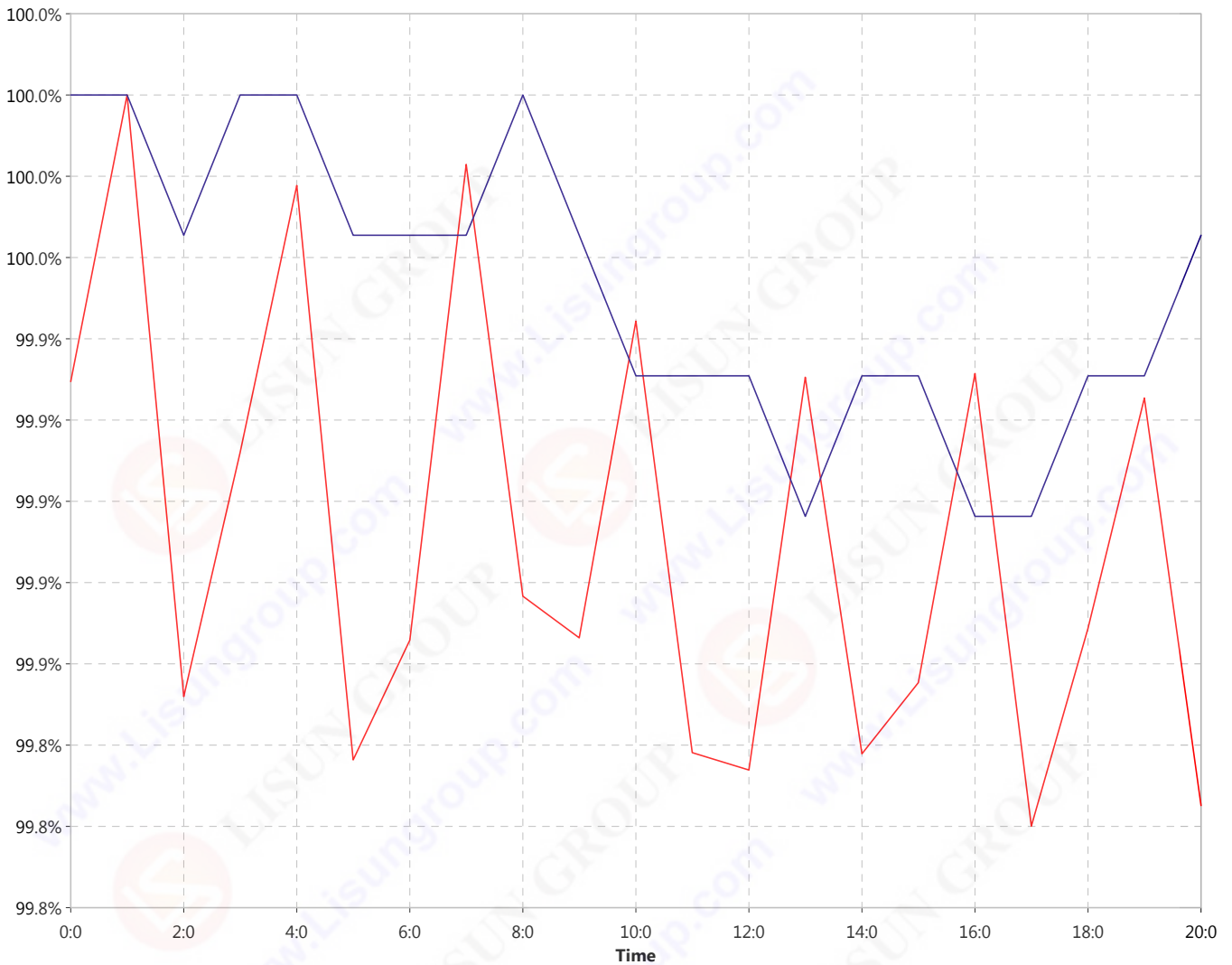

Stable time: 20:0

Uptime: 0:0

Parameters	Maximum	Minimum	Change
Luminous intensity ,cd	658.95	657.70	1.25
Power ,W	27.56	27.53	0.03

 Test Type : Type C Test Distance : 8.160 m
 Test Device : Lisun LSG-1890B (E312012J)
 Test Lab : LISUN Lab
 Test By : David

 C Plane (°): 0.0-180.0:1.0 γ (°): 0.0-180.0:1.0
 Temperature : 25.0°C Humidity : 65.0%

Review By :

UGR

Reflectance											
Ceiling (cavity)		0.7	0.7	0.5	0.5	0.3	0.7	0.7	0.5	0.5	0.3
Wall		0.5	0.3	0.5	0.3	0.3	0.5	0.3	0.5	0.3	0.3
Reference plane		0.2	0.2	0.2	0.2	0.2	0.2	0.2	0.2	0.2	0.2
Room dimensions		Viewed crosswise					Viewed endwise				
X=2H	Y=2H	26.7	28.3	27.1	28.7	29.0	26.9	28.5	27.3	28.9	29.2
	3H	28.2	29.6	28.6	30.0	30.3	28.5	29.9	28.9	30.3	30.6
	4H	28.5	29.9	29.0	30.3	30.7	28.8	30.1	29.2	30.5	30.9
	6H	28.7	29.9	29.1	30.3	30.7	28.9	30.2	29.4	30.6	31.0
	8H	28.7	29.9	29.1	30.3	30.7	28.9	30.1	29.4	30.5	30.9
	12H	28.7	29.8	29.1	30.2	30.6	28.9	30.0	29.3	30.4	30.9
X=4H	Y=2H	27.3	28.7	27.8	29.1	29.5	27.5	28.8	27.9	29.2	29.6
	3H	29.0	30.1	29.4	30.5	30.9	29.3	30.4	29.7	30.8	31.2
	4H	29.4	30.4	29.8	30.8	31.3	29.6	30.7	30.1	31.1	31.5
	6H	29.6	30.4	30.0	30.9	31.4	29.8	30.7	30.3	31.2	31.7
	8H	29.6	30.4	30.0	30.8	31.3	29.8	30.7	30.3	31.1	31.6
	12H	29.6	30.3	30.0	30.8	31.3	29.8	30.6	30.3	31.0	31.5
X=8H	Y=4H	29.5	30.4	30.0	30.8	31.3	29.8	30.6	30.3	31.1	31.5
	6H	29.7	30.4	30.3	30.9	31.4	30.0	30.7	30.5	31.2	31.7
	8H	29.8	30.4	30.3	30.9	31.4	30.0	30.6	30.5	31.1	31.6
	12H	29.7	30.3	30.3	30.8	31.4	30.0	30.5	30.5	31.0	31.6
X=12H	Y=4H	29.5	30.3	30.0	30.8	31.2	29.8	30.5	30.3	31.0	31.5
	6H	29.7	30.3	30.3	30.8	31.4	30.0	30.6	30.5	31.1	31.6
	8H	29.8	30.3	30.3	30.8	31.4	30.0	30.6	30.5	31.1	31.6

Calculate in accordance with CIE 190:2010. The table is corrected with 1000lm ($8\log(F/F_0) = 0.0$).

Reflectance											
Ceiling (cavity)		0.7	0.7	0.5	0.5	0.3	0.7	0.7	0.5	0.5	0.3
Wall		0.5	0.3	0.5	0.3	0.3	0.5	0.3	0.5	0.3	0.3
Reference plane		0.2	0.2	0.2	0.2	0.2	0.2	0.2	0.2	0.2	0.2
Room dimensions		Viewed crosswise					Viewed endwise				
X=2H	Y=2H	27.1	28.5	27.4	28.7	29.0	27.3	28.6	27.6	28.9	29.1
	3H	28.4	29.6	28.7	29.9	30.2	28.6	29.9	29.0	30.1	30.4
	4H	28.7	29.9	29.1	30.2	30.5	28.9	30.1	29.3	30.4	30.7
	6H	28.8	29.9	29.2	30.2	30.5	29.0	30.1	29.4	30.4	30.8
	8H	28.8	29.8	29.2	30.2	30.5	29.0	30.1	29.4	30.4	30.7
	12H	28.8	29.8	29.2	30.1	30.5	29.0	30.0	29.4	30.3	30.7
X=4H	Y=2H	27.8	28.9	28.1	29.2	29.5	27.9	29.0	28.2	29.3	29.7
	3H	29.2	30.2	29.6	30.5	30.9	29.4	30.4	29.8	30.7	31.1
	4H	29.6	30.4	30.0	30.8	31.2	29.8	30.7	30.2	31.1	31.4
	6H	29.7	30.5	30.2	30.9	31.3	30.0	30.7	30.4	31.1	31.6
	8H	29.7	30.4	30.2	30.8	31.3	30.0	30.7	30.4	31.1	31.5
	12H	29.7	30.3	30.2	30.8	31.2	29.9	30.6	30.4	31.0	31.5
X=8H	Y=4H	29.7	30.4	30.2	30.8	31.3	29.9	30.6	30.4	31.1	31.5
	6H	29.9	30.5	30.4	30.9	31.4	30.2	30.7	30.6	31.2	31.7
	8H	29.9	30.4	30.4	30.9	31.4	30.2	30.7	30.7	31.1	31.6
	12H	29.9	30.4	30.4	30.8	31.4	30.2	30.6	30.7	31.1	31.6
X=12H	Y=4H	29.7	30.3	30.2	30.8	31.2	29.9	30.6	30.4	31.0	31.4
	6H	29.9	30.4	30.4	30.9	31.4	30.1	30.6	30.6	31.1	31.6
	8H	29.9	30.4	30.4	30.8	31.4	30.2	30.6	30.7	31.1	31.6
Variations with the observer position at spacings											
S=1.0H		+0.1/-0.2					+0.1/-0.2				
S=1.5H		+0.3/-0.6					+0.4/-0.6				
S=2.0H		+0.7/-1.0					+0.6/-1.0				

Calculate in accordance with CIE Pub.117. The table is corrected with 1000lm ($8\log(F/F_0) = 0.0$).

Report No.: 4

Test Time: 2021-03-09 16:28:41

Page 6 of 29

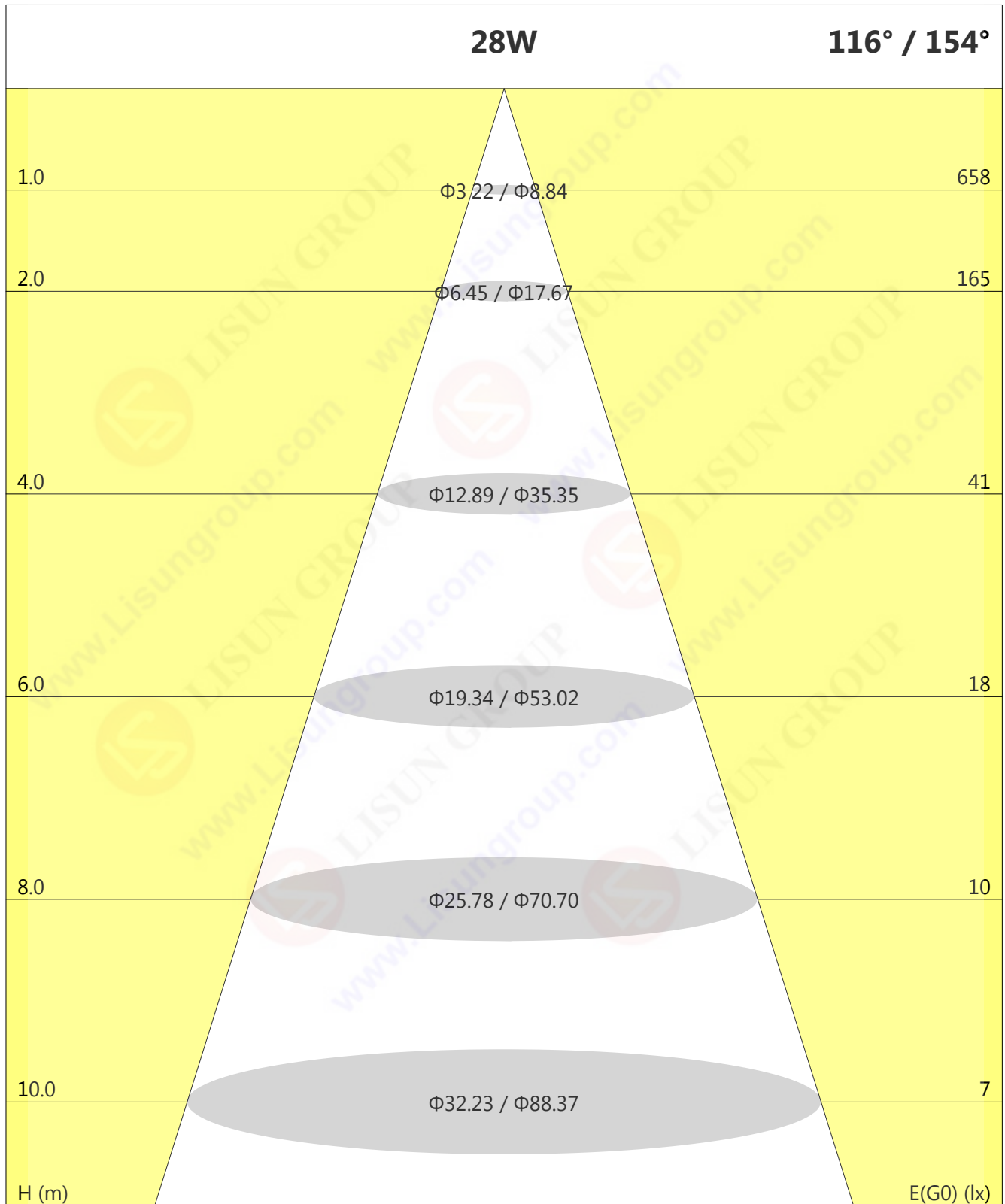
Lux-Distance

Test Type: Type C

Test Distance: 8.160 m

C Plane (°): 0.0-180.0:1.0

 γ (°): 0.0-180.0:1.0

Test Device: Lisun LSG-1890B (E312012J)

Temperature: 25.0°C

Humidity: 65.0%

Test Lab: LISUN Lab

Test By: David

Review By:

IsoLux

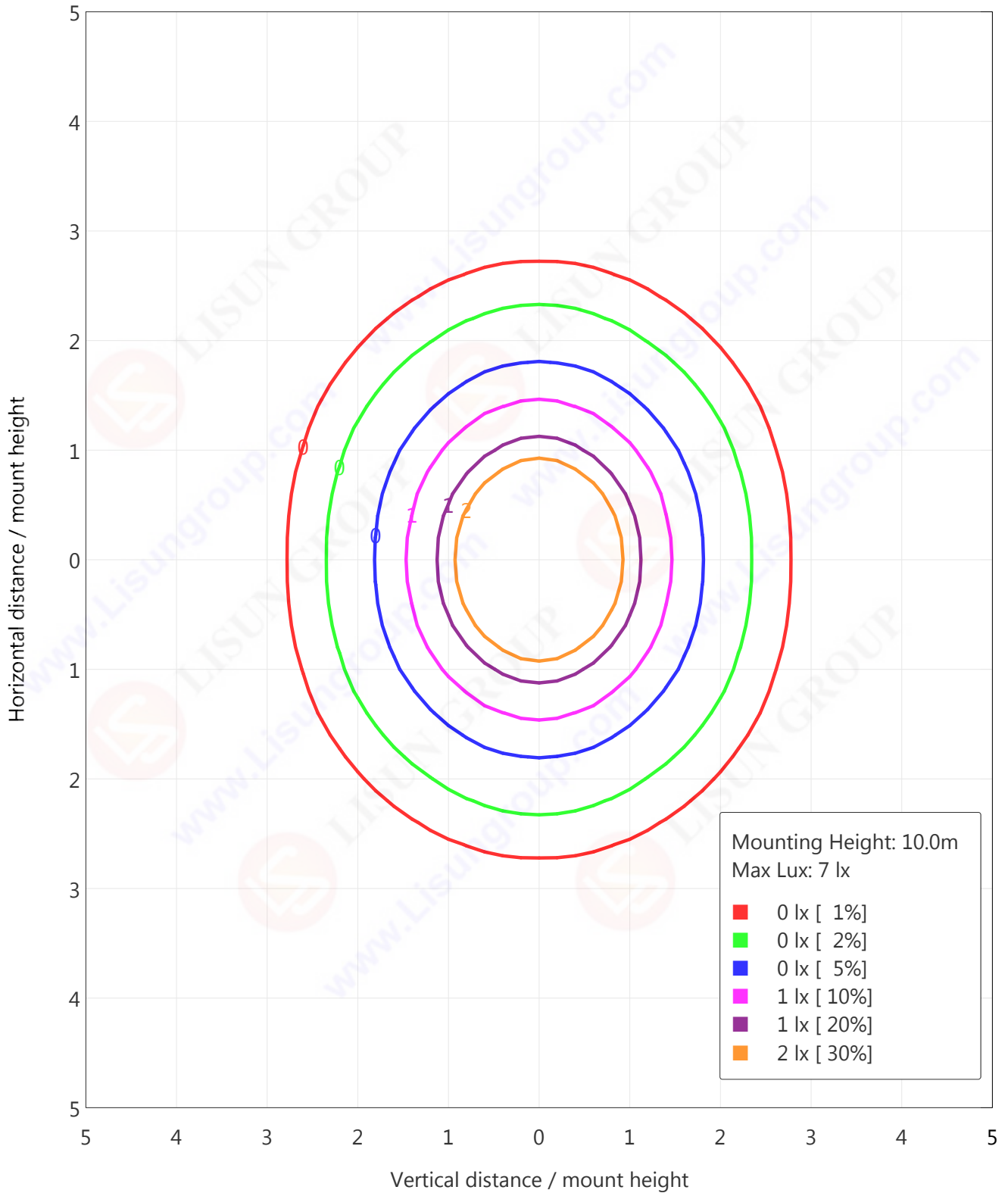

Vertical IsoLux Plot

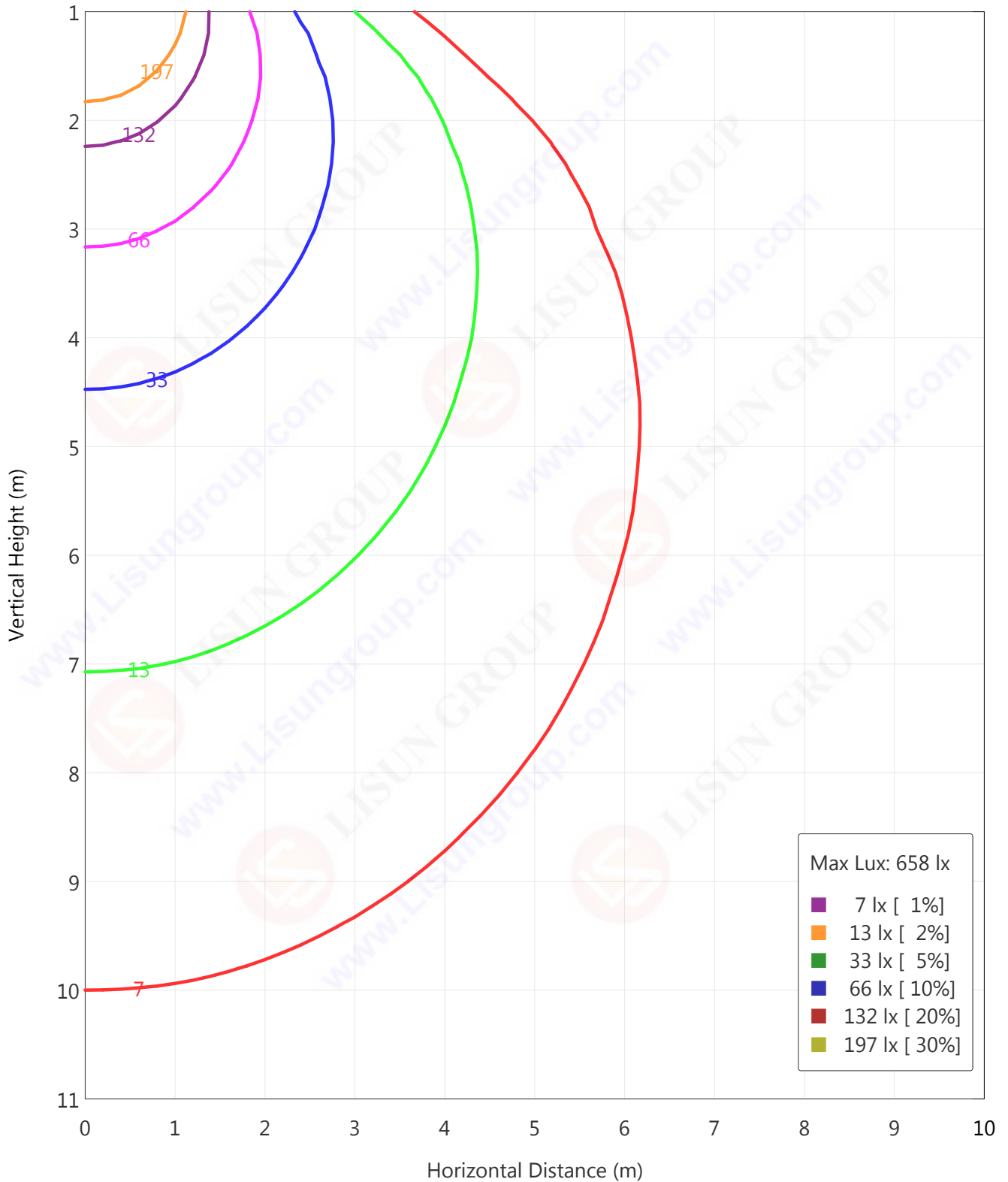

Average Illuminance Effective Figure

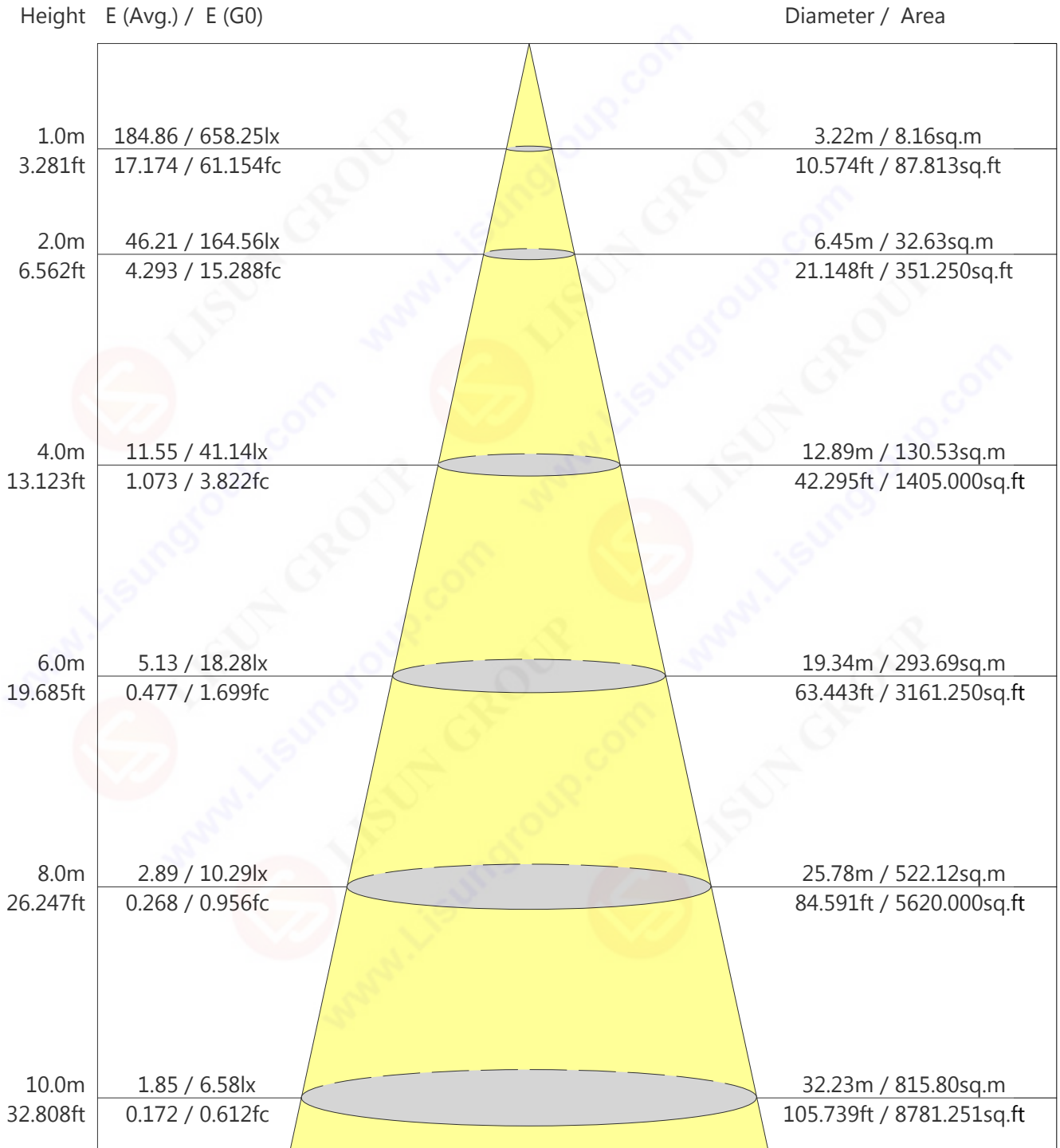

Beam Angle: 116.4° Flux Out: 1508.07lm

Lumen Limit Curve

L (cd/m ²)	G45	G50	G55	G60	G65	G70	G75	G80	G85
C0	66701	65992	64119	61203	55973	44957	35392	20405	5645
C90	66684	65757	63997	61524	57178	50396	33653	19679	4951
C270	66701	65992	64119	61203	55973	44957	35392	20405	5645
C90	66684	65757	63997	61524	57178	50396	33653	19679	4951

Dazzle	Quality	Illuminance (lx)							
1.15	A	2000	1000	500	<=300				
1.50	B	2000		1000	500	<=300			
1.85	C	2000			1000	500	<=300		
2.20	D	2000				1000	500	<=300	
2.55	E	2000			1000	500	<=300		

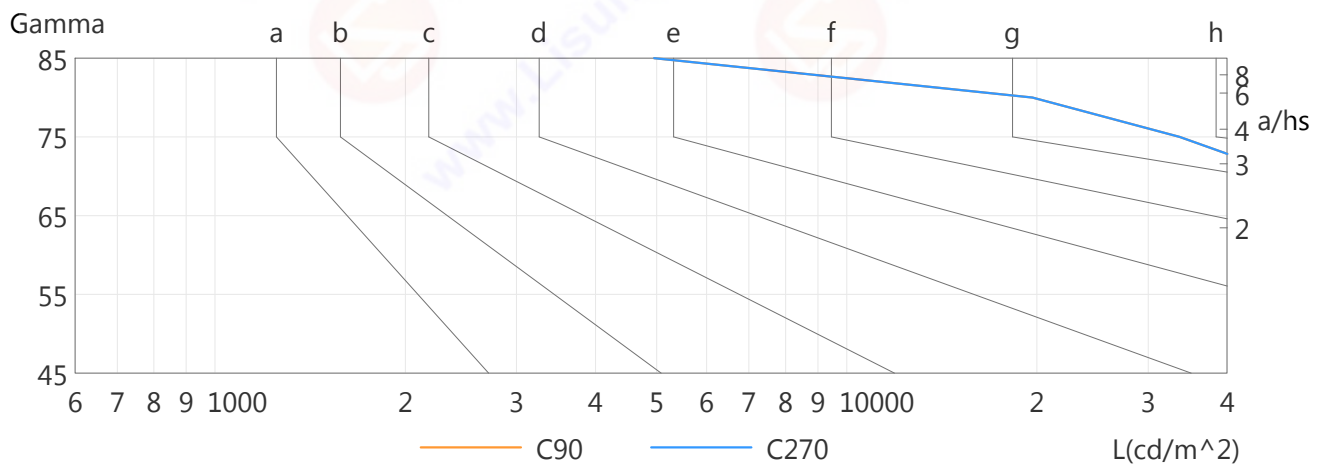
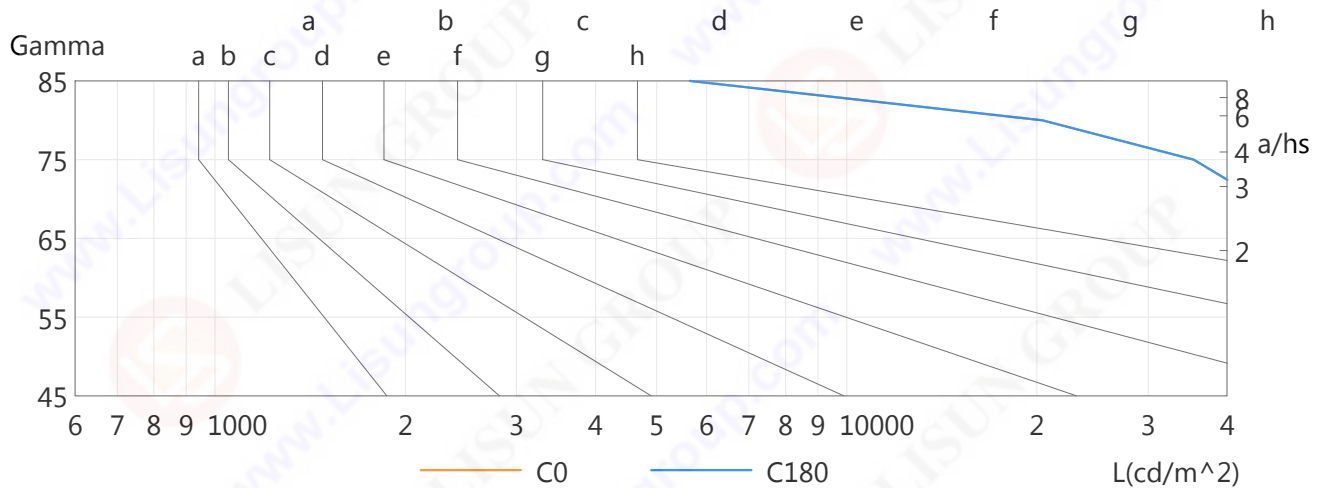

TM5 UF Table

Utilisation Factors UF (F)			SHR NOM = 1.50								
Room Reflectance			Room Index(RI)								
C	W	F	0.75	1.00	1.25	1.50	2.00	2.50	3.00	4.00	5.00
0.70	0.50	0.20	1.16	1.33	1.48	1.58	1.72	1.81	1.88	1.96	2.01
	0.30		1.02	1.19	1.35	1.46	1.61	1.71	1.79	1.89	1.95
	0.20		0.92	1.08	1.24	1.36	1.52	1.63	1.71	1.82	1.90
0.50	0.50	0.20	1.13	1.29	1.43	1.53	1.66	1.74	1.80	1.88	1.93
	0.30		1.01	1.17	1.32	1.42	1.57	1.66	1.73	1.82	1.88
	0.20		0.91	1.07	1.23	1.34	1.49	1.59	1.67	1.77	1.83
0.30	0.50	0.20	1.11	1.25	1.39	1.48	1.60	1.68	1.74	1.81	1.85
	0.30		0.99	1.15	1.29	1.39	1.52	1.61	1.68	1.76	1.81
	0.20		0.91	1.06	1.21	1.31	1.46	1.55	1.62	1.72	1.78
0.00	0.00	0.00	0.87	1.01	1.16	1.26	1.39	1.48	1.55	1.63	1.68

Utilisation Factors UF (W)			SHR NOM = 1.50								
Room Reflectance			Room Index(RI)								
C	W	F	0.75	1.00	1.25	1.50	2.00	2.50	3.00	4.00	5.00
0.70	0.50	0.20	1.79	1.51	1.26	1.09	0.86	0.71	0.60	0.46	0.37
	0.30		1.49	1.29	1.10	0.96	0.78	0.65	0.55	0.43	0.35
	0.20		1.28	1.13	0.97	0.86	0.71	0.60	0.52	0.41	0.34
0.50	0.50	0.20	1.72	1.44	1.20	1.04	0.82	0.74	0.57	0.43	0.35
	0.30		1.46	1.25	1.06	0.93	0.74	0.62	0.53	0.41	0.33
	0.20		1.26	1.11	0.95	0.84	0.69	0.58	0.50	0.39	0.32
0.30	0.50	0.20	1.67	1.39	1.15	0.99	0.78	0.64	0.54	0.41	0.33
	0.30		1.42	1.22	1.03	0.90	0.72	0.60	0.51	0.39	0.32
	0.20		1.25	1.09	0.93	0.82	0.67	0.56	0.48	0.38	0.31
0.00	0.00	0.00	1.04	0.90	0.75	0.65	0.52	0.43	0.36	0.28	0.22

Utilisation Factors UF (C)			SHR NOM = 1.50								
Room Reflectance			Room Index(RI)								
C	W	F	0.75	1.00	1.25	1.50	2.00	2.50	3.00	4.00	5.00
0.70	0.50	0.20	0.32	0.35	0.36	0.37	0.39	0.40	0.41	0.42	0.43
	0.30		0.19	0.23	0.25	0.27	0.30	0.33	0.34	0.37	0.38
	0.20		0.11	0.14	0.17	0.19	0.23	0.26	0.29	0.32	0.34
0.50	0.50	0.20	0.31	0.33	0.35	0.36	0.37	0.38	0.39	0.40	0.41
	0.30		0.19	0.22	0.24	0.27	0.29	0.31	0.33	0.35	0.37
	0.20		0.10	0.14	0.16	0.19	0.23	0.26	0.28	0.31	0.33
0.30	0.50	0.20	0.30	0.32	0.33	0.34	0.36	0.37	0.38	0.39	0.39
	0.30		0.19	0.22	0.24	0.26	0.29	0.31	0.32	0.34	0.36
	0.20		0.10	0.13	0.16	0.19	0.22	0.25	0.27	0.30	0.32
0.00	0.00	0.00	0.01	0.01	0.01	0.01	0.01	0.01	0.01	0.01	0.01

Rating: 28W Photometrically tested without ceiling board.

Multiply UF values by service correction factors

Calculate in accordance with CIBSE Technical Memorandum No.5/1980

Indoor CU, Curves of Luminaires vs Lighting Area

RC	0.8	0.8	0.8	0.8	0.7	0.7	0.7	0.7	0.5	0.5	0.5	0.3	0.3	0.3	0.1	0.1	0.1	0
RW	0.7	0.5	0.3	0.1	0.7	0.5	0.3	0.1	0.5	0.3	0.1	0.5	0.3	0.1	0.5	0.3	0.1	0
RCR	RF = 0.2																	
0	229	229	229	229	223	223	223	223	213	213	213	204	204	204	195	195	195	191
1	210	202	194	187	205	197	190	184	189	183	178	181	177	172	174	170	167	163
2	192	176	164	153	187	173	161	151	166	156	147	159	151	144	153	146	140	136
3	175	155	140	127	170	152	138	126	146	134	124	140	130	121	135	127	119	115
4	160	137	120	108	155	134	119	107	129	116	105	125	113	104	121	110	102	98
5	147	122	105	93	143	120	104	92	116	102	91	112	99	90	108	97	89	84
6	136	110	93	81	132	108	92	80	104	90	79	101	88	78	98	87	78	74
7	126	100	83	71	122	98	82	71	95	80	70	92	79	69	89	78	69	65
8	117	91	74	63	114	89	74	63	87	72	62	84	71	62	82	70	61	58
9	109	83	67	57	106	82	67	56	80	66	56	77	65	56	75	64	55	52
10	102	77	61	51	100	76	61	51	74	60	51	72	59	50	70	58	50	47

Spacing Criteria: 1.31 (0-180), 1.31 (90-270), 1.43 (Diagonal)

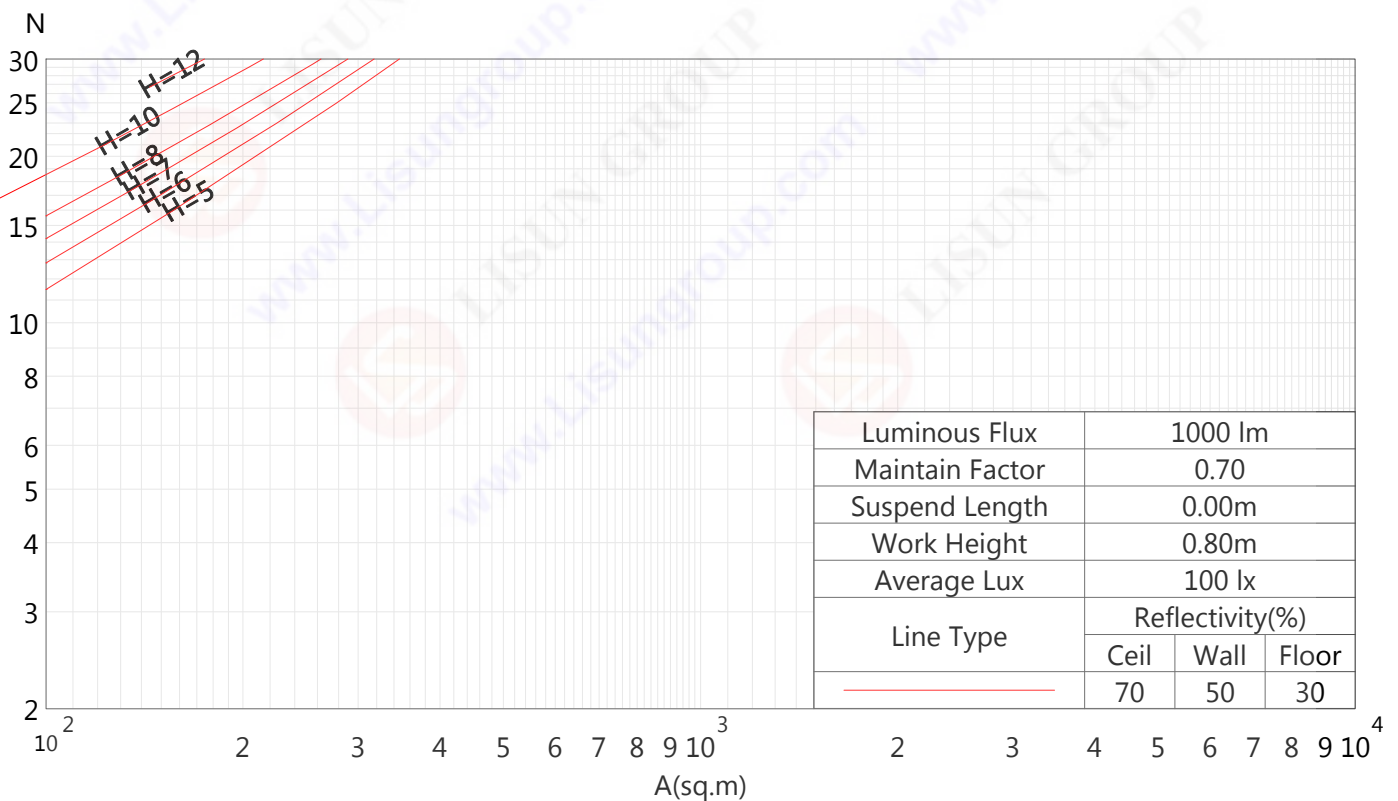

Test Type : Type C Test Distance : 8.160 m
 Test Device : Lisun LSG-1890B (E312012J)
 Test Lab : LISUN Lab
 Test By : David

C Plane (°): 0.0-180.0:1.0 γ (°): 0.0-180.0:1.0
 Temperature : 25.0°C Humidity : 65.0%

Review By :

Report No. : 4

Test Time : 2021-03-09 16:28:41

Page 13 of 29

Zonal Flux

Gamma °	I _{mean} cd	Zonal Flux lm	Sum Zonal Flux lm	Rel Zonal Flux %	Sum Rel Zonal Flux %
0.0-1.0	658.2	0.6	0.6	0.06	0.06
1.0-2.0	658.1	1.9	2.5	0.19	0.25
2.0-3.0	658.0	3.1	5.7	0.31	0.57
3.0-4.0	657.8	4.4	10.1	0.44	1.01
4.0-5.0	657.4	5.7	15.7	0.57	1.57
5.0-6.0	656.7	6.9	22.6	0.69	2.26
6.0-7.0	655.8	8.1	30.8	0.81	3.08
7.0-8.0	654.7	9.4	40.1	0.94	4.01
8.0-9.0	653.4	10.6	50.7	1.06	5.07
9.0-10.0	651.9	11.8	62.5	1.18	6.25
10.0-11.0	650.4	13.0	75.5	1.30	7.55
11.0-12.0	648.6	14.2	89.7	1.42	8.97
12.0-13.0	646.6	15.3	105.1	1.53	10.51
13.0-14.0	644.5	16.5	121.6	1.65	12.16
14.0-15.0	642.2	17.6	139.2	1.76	13.92
15.0-16.0	639.7	18.7	157.9	1.87	15.79
16.0-17.0	636.9	19.8	177.8	1.98	17.78
17.0-18.0	634.1	20.9	198.7	2.09	19.87
18.0-19.0	630.9	22.0	220.6	2.20	22.06
19.0-20.0	627.7	23.0	243.6	2.30	24.36
20.0-21.0	624.4	24.0	267.6	2.40	26.76
21.0-22.0	620.8	25.0	292.5	2.50	29.25
22.0-23.0	616.9	25.9	318.4	2.59	31.84
23.0-24.0	612.8	26.8	345.2	2.68	34.52
24.0-25.0	608.6	27.7	372.9	2.77	37.29
25.0-26.0	604.0	28.5	401.4	2.85	40.14
26.0-27.0	599.2	29.3	430.7	2.93	43.07
27.0-28.0	594.2	30.1	460.8	3.01	46.08
28.0-29.0	589.1	30.8	491.7	3.08	49.17
29.0-30.0	583.7	31.5	523.2	3.15	52.32
30.0-31.0	578.3	32.2	555.4	3.22	55.54
31.0-32.0	572.9	32.8	588.2	3.28	58.82
32.0-33.0	566.8	33.4	621.6	3.34	62.16
33.0-34.0	560.7	33.9	655.5	3.39	65.55
34.0-35.0	554.3	34.4	689.9	3.44	68.99
35.0-36.0	547.7	34.9	724.8	3.49	72.48
36.0-37.0	540.9	35.3	760.1	3.53	76.01
37.0-38.0	533.6	35.6	795.7	3.56	79.57
38.0-39.0	526.5	35.9	831.7	3.59	83.17
39.0-40.0	519.3	36.2	867.9	3.62	86.79

 Test Type : Type C Test Distance : 8.160 m
 Test Device : Lisun LSG-1890B (E312012J)
 Test Lab : LISUN Lab
 Test By : David

 C Plane (°): 0.0-180.0:1.0 γ (°): 0.0-180.0:1.0
 Temperature : 25.0°C Humidity : 65.0%

Review By :

Report No. : 4

Test Time : 2021-03-09 16:28:41

Page 14 of 29

Zonal Flux

Gamma °	Imean cd	Zonal Flux lm	Sum Zonal Flux lm	Rel Zonal Flux %	Sum Rel Zonal Flux %
40.0-41.0	511.7	36.4	904.3	3.64	90.43
41.0-42.0	503.5	36.6	940.9	3.66	94.09
42.0-43.0	495.1	36.7	977.6	3.67	97.76
43.0-44.0	486.5	36.7	1014.3	3.67	101.43
44.0-45.0	477.8	36.7	1051.1	3.67	105.11
45.0-46.0	469.2	36.7	1087.8	3.67	108.78
46.0-47.0	460.3	36.6	1124.4	3.66	112.44
47.0-48.0	450.6	36.4	1160.8	3.64	116.08
48.0-49.0	440.3	36.2	1197.0	3.62	119.70
49.0-50.0	430.0	35.9	1232.8	3.59	123.28
50.0-51.0	419.6	35.5	1268.3	3.55	126.83
51.0-52.0	409.4	35.1	1303.5	3.51	130.35
52.0-53.0	398.9	34.7	1338.2	3.47	133.82
53.0-54.0	387.7	34.2	1372.3	3.42	137.23
54.0-55.0	375.7	33.5	1405.9	3.35	140.59
55.0-56.0	363.8	32.9	1438.8	3.29	143.88
56.0-57.0	352.6	32.2	1471.0	3.22	147.10
57.0-58.0	341.0	31.5	1502.5	3.15	150.25
58.0-59.0	328.0	30.7	1533.2	3.07	153.32
59.0-60.0	314.8	29.7	1563.0	2.97	156.30
60.0-61.0	301.9	28.8	1591.8	2.88	159.18
61.0-62.0	287.9	27.7	1619.5	2.77	161.95
62.0-63.0	272.8	26.5	1646.0	2.65	164.60
63.0-64.0	259.9	25.5	1671.5	2.55	167.15
64.0-65.0	248.2	24.6	1696.1	2.46	169.61
65.0-66.0	235.1	23.5	1719.6	2.35	171.96
66.0-67.0	221.7	22.3	1741.9	2.23	174.19
67.0-68.0	206.3	20.9	1762.8	2.09	176.28
68.0-69.0	190.8	19.5	1782.2	1.95	178.22
69.0-70.0	176.7	18.2	1800.4	1.82	180.04
70.0-71.0	162.0	16.7	1817.1	1.67	181.71
71.0-72.0	146.1	15.2	1832.3	1.52	183.23
72.0-73.0	130.0	13.6	1845.9	1.36	184.59
73.0-74.0	114.2	12.0	1857.9	1.20	185.79
74.0-75.0	98.3	10.4	1868.3	1.04	186.83
75.0-76.0	84.4	9.0	1877.3	0.90	187.73
76.0-77.0	72.6	7.7	1885.0	0.77	188.50
77.0-78.0	62.0	6.6	1891.7	0.66	189.17
78.0-79.0	50.6	5.4	1897.1	0.54	189.71
79.0-80.0	40.2	4.3	1901.4	0.43	190.14

 Test Type : Type C Test Distance : 8.160 m
 Test Device : Lisun LSG-1890B (E312012J)
 Test Lab : LISUN Lab
 Test By : David

 C Plane (°): 0.0-180.0:1.0 γ (°): 0.0-180.0:1.0
 Temperature : 25.0°C Humidity : 65.0%

Review By :

Zonal Flux

Gamma °	I _{mean} cd	Zonal Flux lm	Sum Zonal Flux lm	Rel Zonal Flux %	Sum Rel Zonal Flux %
80.0-81.0	31.5	3.4	1904.8	0.34	190.48
81.0-82.0	22.9	2.5	1907.3	0.25	190.73
82.0-83.0	16.2	1.8	1909.1	0.18	190.91
83.0-84.0	11.0	1.2	1910.3	0.12	191.03
84.0-85.0	6.8	0.7	1911.0	0.07	191.10
85.0-86.0	4.1	0.4	1911.5	0.04	191.15
86.0-87.0	2.4	0.3	1911.7	0.03	191.17
87.0-88.0	1.4	0.2	1911.9	0.02	191.19
88.0-89.0	0.8	0.1	1912.0	0.01	191.20
89.0-90.0	0.6	0.1	1912.0	0.01	191.20
90.0-91.0	0.5	0.1	1912.1	0.01	191.21
91.0-92.0	0.6	0.1	1912.2	0.01	191.22
92.0-93.0	0.6	0.1	1912.2	0.01	191.22
93.0-94.0	0.6	0.1	1912.3	0.01	191.23
94.0-95.0	0.7	0.1	1912.4	0.01	191.24
95.0-96.0	0.7	0.1	1912.5	0.01	191.25
96.0-97.0	0.8	0.1	1912.5	0.01	191.25
97.0-98.0	0.8	0.1	1912.6	0.01	191.26
98.0-99.0	0.9	0.1	1912.7	0.01	191.27
99.0-100.0	0.9	0.1	1912.8	0.01	191.28
100.0-101.0	1.0	0.1	1912.9	0.01	191.29
101.0-102.0	1.0	0.1	1913.0	0.01	191.30
102.0-103.0	1.1	0.1	1913.1	0.01	191.31
103.0-104.0	1.1	0.1	1913.3	0.01	191.33
104.0-105.0	1.2	0.1	1913.4	0.01	191.34
105.0-106.0	1.2	0.1	1913.5	0.01	191.35
106.0-107.0	1.3	0.1	1913.7	0.01	191.37
107.0-108.0	1.3	0.1	1913.8	0.01	191.38
108.0-109.0	1.4	0.1	1913.9	0.01	191.39
109.0-110.0	1.5	0.2	1914.1	0.02	191.41
110.0-111.0	1.5	0.2	1914.2	0.02	191.42
111.0-112.0	1.6	0.2	1914.4	0.02	191.44
112.0-113.0	1.6	0.2	1914.6	0.02	191.46
113.0-114.0	1.7	0.2	1914.7	0.02	191.47
114.0-115.0	1.8	0.2	1914.9	0.02	191.49
115.0-116.0	1.8	0.2	1915.1	0.02	191.51
116.0-117.0	1.9	0.2	1915.3	0.02	191.53
117.0-118.0	1.9	0.2	1915.5	0.02	191.55
118.0-119.0	2.0	0.2	1915.7	0.02	191.57
119.0-120.0	2.1	0.2	1915.9	0.02	191.59

 Test Type : Type C Test Distance : 8.160 m
 Test Device : Lisun LSG-1890B (E312012J)
 Test Lab : LISUN Lab
 Test By : David

 C Plane (°): 0.0-180.0:1.0 γ (°): 0.0-180.0:1.0
 Temperature : 25.0°C Humidity : 65.0%

Review By :

Report No. : 4

Test Time : 2021-03-09 16:28:41

Page 16 of 29

Zonal Flux

Gamma °	I _{mean} cd	Zonal Flux lm	Sum Zonal Flux lm	Rel Zonal Flux %	Sum Rel Zonal Flux %
120.0-121.0	2.1	0.2	1916.1	0.02	191.61
121.0-122.0	2.2	0.2	1916.3	0.02	191.63
122.0-123.0	2.2	0.2	1916.5	0.02	191.65
123.0-124.0	2.3	0.2	1916.7	0.02	191.67
124.0-125.0	2.4	0.2	1916.9	0.02	191.69
125.0-126.0	2.4	0.2	1917.1	0.02	191.71
126.0-127.0	2.5	0.2	1917.3	0.02	191.73
127.0-128.0	2.6	0.2	1917.6	0.02	191.76
128.0-129.0	2.6	0.2	1917.8	0.02	191.78
129.0-130.0	2.7	0.2	1918.0	0.02	191.80
130.0-131.0	2.7	0.2	1918.2	0.02	191.82
131.0-132.0	2.8	0.2	1918.5	0.02	191.85
132.0-133.0	2.9	0.2	1918.7	0.02	191.87
133.0-134.0	2.9	0.2	1918.9	0.02	191.89
134.0-135.0	3.0	0.2	1919.2	0.02	191.92
135.0-136.0	3.1	0.2	1919.4	0.02	191.94
136.0-137.0	3.1	0.2	1919.6	0.02	191.96
137.0-138.0	3.2	0.2	1919.9	0.02	191.99
138.0-139.0	3.2	0.2	1920.1	0.02	192.01
139.0-140.0	3.3	0.2	1920.3	0.02	192.03
140.0-141.0	3.3	0.2	1920.6	0.02	192.06
141.0-142.0	3.4	0.2	1920.8	0.02	192.08
142.0-143.0	3.5	0.2	1921.0	0.02	192.10
143.0-144.0	3.5	0.2	1921.3	0.02	192.13
144.0-145.0	3.6	0.2	1921.5	0.02	192.15
145.0-146.0	3.6	0.2	1921.7	0.02	192.17
146.0-147.0	3.7	0.2	1921.9	0.02	192.19
147.0-148.0	3.7	0.2	1922.2	0.02	192.22
148.0-149.0	3.8	0.2	1922.4	0.02	192.24
149.0-150.0	3.8	0.2	1922.6	0.02	192.26
150.0-151.0	3.9	0.2	1922.8	0.02	192.28
151.0-152.0	3.9	0.2	1923.0	0.02	192.30
152.0-153.0	3.9	0.2	1923.2	0.02	192.32
153.0-154.0	4.0	0.2	1923.4	0.02	192.34
154.0-155.0	4.0	0.2	1923.6	0.02	192.36
155.0-156.0	4.1	0.2	1923.8	0.02	192.38
156.0-157.0	4.1	0.2	1923.9	0.02	192.39
157.0-158.0	4.1	0.2	1924.1	0.02	192.41
158.0-159.0	4.2	0.2	1924.3	0.02	192.43
159.0-160.0	4.2	0.2	1924.4	0.02	192.44

 Test Type : Type C Test Distance : 8.160 m
 Test Device : Lisun LSG-1890B (E312012J)
 Test Lab : LISUN Lab
 Test By : David

 C Plane (°): 0.0-180.0:1.0 γ (°): 0.0-180.0:1.0
 Temperature : 25.0°C Humidity : 65.0%

Review By :

Report No. : 4

Test Time : 2021-03-09 16:28:41

Page 17 of 29

Zonal Flux

Gamma °	I _{mean} cd	Zonal Flux lm	Sum Zonal Flux lm	Rel Zonal Flux %	Sum Rel Zonal Flux %
160.0-161.0	4.2	0.2	1924.6	0.02	192.46
161.0-162.0	4.3	0.1	1924.8	0.01	192.48
162.0-163.0	4.3	0.1	1924.9	0.01	192.49
163.0-164.0	4.3	0.1	1925.0	0.01	192.50
164.0-165.0	4.4	0.1	1925.2	0.01	192.52
165.0-166.0	4.4	0.1	1925.3	0.01	192.53
166.0-167.0	4.4	0.1	1925.4	0.01	192.54
167.0-168.0	4.4	0.1	1925.5	0.01	192.55
168.0-169.0	4.5	0.1	1925.6	0.01	192.56
169.0-170.0	4.5	0.1	1925.7	0.01	192.57
170.0-171.0	4.5	0.1	1925.8	0.01	192.58
171.0-172.0	4.5	0.1	1925.8	0.01	192.58
172.0-173.0	4.5	0.1	1925.9	0.01	192.59
173.0-174.0	4.6	0.1	1926.0	0.01	192.60
174.0-175.0	4.6	0.0	1926.0	0.00	192.60
175.0-176.0	4.6	0.0	1926.0	0.00	192.60
176.0-177.0	4.6	0.0	1926.1	0.00	192.61
177.0-178.0	4.6	0.0	1926.1	0.00	192.61
178.0-179.0	4.6	0.0	1926.1	0.00	192.61
179.0-180.0	4.6	0.0	1926.1	0.00	192.61

 Test Type : Type C
 Test Device : Lisun LSG-1890B (E312012J)
 Test Lab : LISUN Lab
 Test By : David

Test Distance : 8.160 m

 C Plane (°): 0.0-180.0:1.0
 Temperature : 25.0°C

 γ (°): 0.0-180.0:1.0
 Humidity : 65.0%

Review By :

Report No. : 4

Test Time : 2021-03-09 16:28:41

Page 18 of 29

Light Distribution Data

Unit: cd

G\C	C0.0	C30.0	C60.0	C90.0				
G0.0	658.3	658.3	658.3	658.3				
G1.0	658.3	658.2	658.2	658.2				
G2.0	658.3	658.1	658.0	658.1				
G3.0	658.0	657.9	657.9	658.0				
G4.0	657.8	657.4	657.8	657.7				
G5.0	657.3	656.9	657.2	657.3				
G6.0	656.4	656.2	656.3	656.3				
G7.0	655.7	655.0	655.4	655.4				
G8.0	654.4	653.7	654.3	654.3				
G9.0	652.9	652.2	652.9	653.0				
G10.0	651.4	650.4	651.5	651.8				
G11.0	649.6	648.7	650.0	650.3				
G12.0	647.4	647.0	648.1	648.4				
G13.0	645.1	644.7	646.2	646.4				
G14.0	642.8	642.7	644.2	644.4				
G15.0	640.0	640.1	641.9	641.9				
G16.0	637.3	637.3	639.5	639.4				
G17.0	634.2	634.3	636.8	636.5				
G18.0	631.4	631.4	634.1	633.4				
G19.0	627.9	627.7	631.0	630.4				
G20.0	624.5	624.4	628.1	627.1				
G21.0	620.9	620.8	624.8	623.7				
G22.0	617.2	616.9	621.3	620.0				
G23.0	613.0	612.6	617.4	615.9				
G24.0	608.4	608.7	613.9	611.4				
G25.0	604.3	603.8	609.4	607.3				
G26.0	599.2	599.3	605.2	602.2				
G27.0	594.6	593.9	600.0	597.5				
G28.0	589.7	588.9	595.2	592.5				
G29.0	584.6	583.5	589.9	587.1				
G30.0	579.2	577.8	584.5	581.5				
G31.0	573.5	572.9	579.7	575.6				
G32.0	568.5	566.8	573.8	570.5				
G33.0	562.1	560.3	567.5	564.0				
G34.0	556.5	554.6	562.0	556.8				
G35.0	549.4	547.3	555.2	550.7				
G36.0	543.1	541.0	549.3	544.2				
G37.0	535.1	533.2	543.0	535.9				
G38.0	528.1	526.2	535.2	528.9				
G39.0	520.8	519.2	528.4	521.8				

Test Type : Type C

Test Distance : 8.160 m

C Plane (°): 0.0-180.0:1.0

γ (°): 0.0-180.0:1.0

Test Device : Lisun LSG-1890B (E312012J)

Temperature : 25.0°C

Humidity : 65.0%

Test Lab : LISUN Lab

Test By : David

Review By :

Report No. : 4

Test Time : 2021-03-09 16:28:41

Page 19 of 29

Light Distribution Data

Unit: cd

G\C	C0.0	C30.0	C60.0	C90.0				
G40.0	513.4	511.7	521.3	514.3				
G41.0	506.0	504.1	513.9	504.9				
G42.0	496.6	494.8	506.0	496.9				
G43.0	488.4	486.8	497.8	488.5				
G44.0	480.0	478.3	487.9	480.0				
G45.0	471.7	469.6	479.6	471.5				
G46.0	463.3	460.7	471.0	462.6				
G47.0	454.4	451.4	462.0	453.5				
G48.0	445.2	439.7	452.6	442.3				
G49.0	433.8	429.9	442.7	432.6				
G50.0	424.2	419.8	430.8	422.7				
G51.0	414.2	409.6	420.4	412.9				
G52.0	403.8	399.4	410.1	402.8				
G53.0	392.8	388.8	399.1	392.2				
G54.0	381.7	377.8	388.1	378.5				
G55.0	367.8	364.3	376.8	367.1				
G56.0	356.0	353.0	365.4	355.5				
G57.0	343.9	343.7	353.7	343.9				
G58.0	331.4	328.9	339.5	341.6				
G59.0	318.8	316.8	327.3	319.7				
G60.0	306.0	304.0	314.9	307.6				
G61.0	290.5	291.4	302.4	292.8				
G62.0	271.7	275.7	290.1	280.1				
G63.0	266.2	262.0	266.3	267.1				
G64.0	250.0	248.1	264.0	254.3				
G65.0	236.6	234.1	251.9	241.6				
G66.0	223.0	220.6	238.8	229.1				
G67.0	208.0	206.9	225.6	216.2				
G68.0	190.7	190.3	208.1	198.9				
G69.0	173.2	177.2	195.0	186.1				
G70.0	153.8	164.0	181.5	172.4				
G71.0	139.5	150.9	164.9	156.3				
G72.0	125.7	137.1	144.6	136.5				
G73.0	114.3	125.3	126.0	117.3				
G74.0	102.4	110.1	107.3	99.0				
G75.0	91.6	87.7	94.4	87.1				
G76.0	81.3	72.1	83.9	76.7				
G77.0	68.5	59.2	73.7	67.2				
G78.0	57.7	49.9	63.7	57.3				
G79.0	42.2	42.6	47.7	41.9				

 Test Type : Type C
 Test Device : Lisun LSG-1890B (E312012J)
 Test Lab : LISUN Lab
 Test By : David

Test Distance : 8.160 m

C Plane (°): 0.0-180.0:1.0

Temperature : 25.0°C

 γ (°): 0.0-180.0:1.0

Humidity : 65.0%

Review By :

Report No. : 4

Test Time : 2021-03-09 16:28:41

Page 20 of 29

Light Distribution Data

Unit: cd

G\C	C0.0	C30.0	C60.0	C90.0				
G80.0	35.4	34.9	38.9	34.2				
G81.0	25.5	24.3	30.5	25.7				
G82.0	20.4	17.1	21.3	17.5				
G83.0	13.6	11.5	16.1	11.4				
G84.0	8.0	7.6	10.4	7.6				
G85.0	4.9	4.6	6.0	4.3				
G86.0	3.5	2.8	3.5	2.5				
G87.0	2.2	1.7	2.0	1.2				
G88.0	1.3	0.9	1.0	0.6				
G89.0	0.8	0.7	0.5	0.5				
G90.0	0.5	0.5	0.5	0.5				
G91.0	0.5	0.6	0.5	0.6				
G92.0	0.6	0.6	0.6	0.6				
G93.0	0.6	0.6	0.6	0.6				
G94.0	0.7	0.7	0.6	0.7				
G95.0	0.7	0.7	0.7	0.7				
G96.0	0.7	0.8	0.7	0.8				
G97.0	0.8	0.8	0.8	0.8				
G98.0	0.8	0.9	0.8	0.8				
G99.0	0.9	0.9	0.9	0.9				
G100.0	0.9	1.0	0.9	0.9				
G101.0	1.0	1.0	1.0	1.0				
G102.0	1.0	1.1	1.0	1.0				
G103.0	1.1	1.1	1.1	1.1				
G104.0	1.1	1.2	1.1	1.2				
G105.0	1.2	1.2	1.2	1.2				
G106.0	1.2	1.3	1.2	1.3				
G107.0	1.3	1.3	1.3	1.3				
G108.0	1.4	1.4	1.4	1.4				
G109.0	1.4	1.5	1.4	1.4				
G110.0	1.5	1.5	1.5	1.5				
G111.0	1.5	1.6	1.5	1.6				
G112.0	1.6	1.6	1.6	1.6				
G113.0	1.6	1.7	1.6	1.7				
G114.0	1.7	1.7	1.7	1.7				
G115.0	1.8	1.8	1.8	1.8				
G116.0	1.8	1.9	1.8	1.8				
G117.0	1.9	1.9	1.9	1.9				
G118.0	2.0	2.0	1.9	2.0				
G119.0	2.0	2.0	2.0	2.0				

 Test Type : Type C
 Test Device : Lisun LSG-1890B (E312012J)
 Test Lab : LISUN Lab
 Test By : David

Test Distance : 8.160 m

C Plane (°): 0.0-180.0:1.0

Temperature : 25.0°C

 γ (°): 0.0-180.0:1.0

Humidity : 65.0%

Review By :

Report No. : 4

Test Time : 2021-03-09 16:28:41

Page 21 of 29

Light Distribution Data

Unit: cd

G\C	C0.0	C30.0	C60.0	C90.0				
G120.0	2.1	2.1	2.1	2.1				
G121.0	2.1	2.2	2.1	2.2				
G122.0	2.2	2.2	2.2	2.2				
G123.0	2.3	2.3	2.3	2.3				
G124.0	2.3	2.4	2.3	2.3				
G125.0	2.4	2.4	2.4	2.4				
G126.0	2.4	2.5	2.4	2.5				
G127.0	2.5	2.6	2.5	2.5				
G128.0	2.6	2.6	2.6	2.6				
G129.0	2.6	2.7	2.6	2.6				
G130.0	2.7	2.7	2.7	2.7				
G131.0	2.8	2.8	2.8	2.8				
G132.0	2.8	2.8	2.8	2.8				
G133.0	2.9	2.9	2.9	2.9				
G134.0	2.9	3.0	3.0	3.0				
G135.0	3.0	3.0	3.0	3.0				
G136.0	3.1	3.1	3.1	3.1				
G137.0	3.1	3.2	3.1	3.1				
G138.0	3.2	3.2	3.2	3.2				
G139.0	3.2	3.3	3.3	3.3				
G140.0	3.3	3.3	3.3	3.3				
G141.0	3.4	3.4	3.4	3.4				
G142.0	3.4	3.4	3.4	3.4				
G143.0	3.5	3.5	3.5	3.5				
G144.0	3.5	3.6	3.5	3.5				
G145.0	3.6	3.6	3.6	3.6				
G146.0	3.6	3.6	3.6	3.6				
G147.0	3.7	3.7	3.7	3.7				
G148.0	3.7	3.8	3.8	3.7				
G149.0	3.8	3.8	3.8	3.8				
G150.0	3.8	3.8	3.8	3.8				
G151.0	3.9	3.9	3.9	3.9				
G152.0	3.9	3.9	3.9	3.9				
G153.0	3.9	4.0	4.0	4.0				
G154.0	4.0	4.0	4.0	4.0				
G155.0	4.0	4.1	4.1	4.0				
G156.0	4.1	4.1	4.1	4.1				
G157.0	4.1	4.1	4.1	4.1				
G158.0	4.1	4.2	4.2	4.2				
G159.0	4.2	4.2	4.2	4.2				

 Test Type : Type C Test Distance : 8.160 m
 Test Device : Lisun LSG-1890B (E312012J)
 Test Lab : LISUN Lab
 Test By : David

 C Plane (°): 0.0-180.0:1.0 γ (°): 0.0-180.0:1.0
 Temperature : 25.0°C Humidity : 65.0%
 Review By :

Report No.: 4

Test Time : 2021-03-09 16:28:41

Page 22 of 29

Light Distribution Data

Unit: cd

G\C	C0.0	C30.0	C60.0	C90.0				
G160.0	4.2	4.2	4.2	4.2				
G161.0	4.2	4.3	4.3	4.3				
G162.0	4.3	4.3	4.3	4.3				
G163.0	4.3	4.3	4.4	4.3				
G164.0	4.3	4.3	4.4	4.3				
G165.0	4.4	4.4	4.4	4.4				
G166.0	4.4	4.4	4.4	4.4				
G167.0	4.4	4.4	4.5	4.4				
G168.0	4.4	4.4	4.5	4.4				
G169.0	4.5	4.5	4.5	4.5				
G170.0	4.5	4.5	4.5	4.5				
G171.0	4.5	4.5	4.5	4.5				
G172.0	4.5	4.5	4.6	4.5				
G173.0	4.5	4.5	4.6	4.5				
G174.0	4.5	4.6	4.6	4.6				
G175.0	4.6	4.6	4.6	4.6				
G176.0	4.6	4.6	4.6	4.6				
G177.0	4.6	4.6	4.6	4.6				
G178.0	4.6	4.6	4.6	4.6				
G179.0	4.6	4.6	4.6	4.6				
G180.0	4.6	4.6	4.6	4.6				

 Test Type : Type C Test Distance : 8.160 m
 Test Device : Lisun LSG-1890B (E312012J)
 Test Lab : LISUN Lab
 Test By : David

 C Plane (°): 0.0-180.0:1.0 γ (°): 0.0-180.0:1.0
 Temperature : 25.0°C Humidity : 65.0%
 Review By :

Color Properties

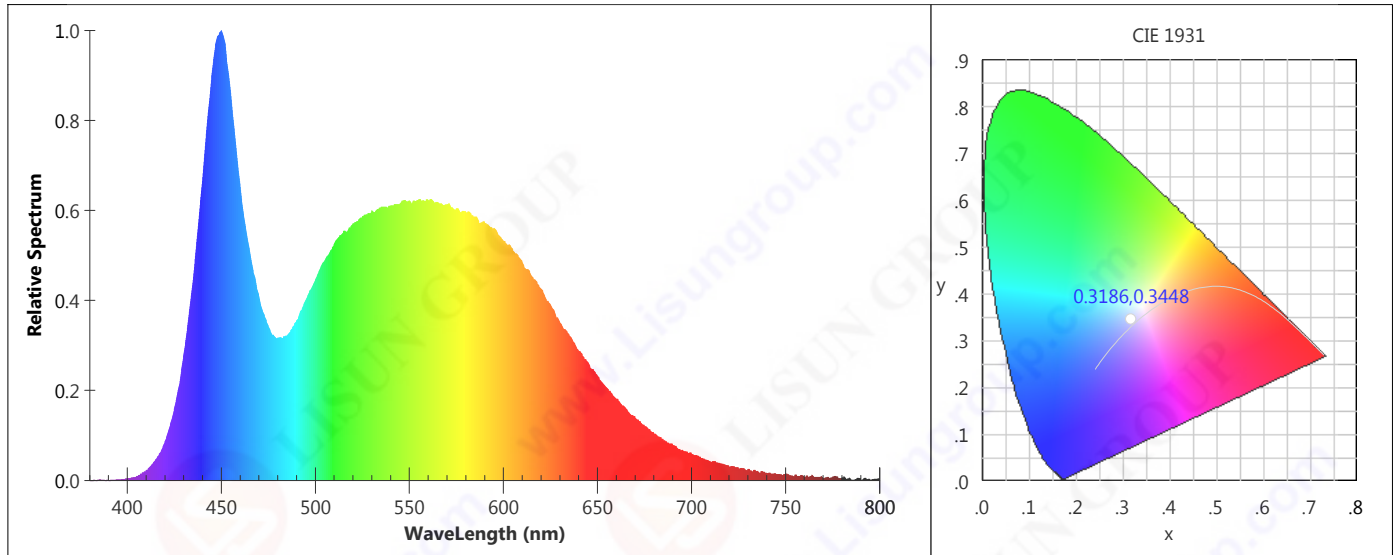

Colorimetric

CIE(x,y): 0.3186,0.3448

CIE(u,v): 0.1961,0.3183

CIE(u',v'): 0.1961,0.4774

CCT: 6120 K (Duv=0.008240)

Dominant Wavelength: 502.1 nm

Color Purity: 0.045

Peak Wavelength: 449.8 nm

Half Width: 29.2 nm

Color Ratio: R:0.131, G:0.816, B:0.053

Color Render Index: Ra: 80.8

R1: 77	R2: 85	R3: 91	R4: 80	R5: 79	R6: 80	R7: 87	R8: 66
--------	--------	--------	--------	--------	--------	--------	--------

R9: -7	R10: 65	R11: 85	R12: 61	R13: 79	R14: 95	R15: 71
--------	---------	---------	---------	---------	---------	---------

Color Quality Scale: Qa: 81.2, Qf: 81.5, Qp: 80.7, Qg: 90.1

Q1: 83	Q2: 98	Q3: 80	Q4: 76	Q5: 80	Q6: 82	Q7: 84	Q8: 89
--------	--------	--------	--------	--------	--------	--------	--------

Q9: 97	Q10: 87	Q11: 83	Q12: 82	Q13: 82	Q14: 67	Q15: 73
--------	---------	---------	---------	---------	---------	---------

TM-30-18: Rf: 83, Rg: 94

Report No. : 4

Test Time : 2021-03-09 16:28:41

Page 24 of 29

Color Distribution Data

Evaluation of Spatial non-uniformity of chromaticity

IESNA LM-79: Spatially Averaged Chromaticity (u',v'): 0.1959, 0.4791
 Spatially Averaged Chromaticity (CCT): 6044K
 Spatial non-uniformity of chromaticity $\Delta u'v'(\Delta u',\Delta v')$: 0.004597 (0.0003,0.0046)
 CIE S025: Spatially Averaged Chromaticity (u',v'): 0.1959, 0.4791
 Spatially Averaged Chromaticity (CCT): 6042K
 Angular Colour Uniformity $\Delta u'v'(\Delta u',\Delta v')$: 0.004574 (0.0003,0.0046)
 GB/T 24824: Spatially Averaged Chromaticity (u',v'): 0.1959, 0.4791
 Average Color Nonuniformity $\Delta u'v'(\Delta u',\Delta v')$:0.001774 (-0.0001,0.0018)
 Maximum Color Nonuniformity $\Delta u'v'(\Delta u',\Delta v')$:0.006360 (0.0002,0.0064)

Color Distribution Data (x,y)

Average Color(x,y):(0.3200,0.3478)

G\C	0.0	30.0	60.0	90.0
0.0	0.3186,0.3447	0.3187,0.3449	0.3186,0.3448	0.3185,0.3448
2.0	0.3187,0.3449	0.3186,0.3448	0.3185,0.3448	0.3188,0.3451
4.0	0.3186,0.3448	0.3185,0.3448	0.3188,0.3451	0.3186,0.3448
6.0	0.3185,0.3448	0.3188,0.3451	0.3186,0.3448	0.3187,0.3451
8.0	0.3188,0.3451	0.3186,0.3448	0.3187,0.3451	0.3189,0.3454
10.0	0.3186,0.3448	0.3187,0.3451	0.3189,0.3454	0.3188,0.3453
12.0	0.3187,0.3451	0.3189,0.3454	0.3188,0.3453	0.3187,0.3451
14.0	0.3189,0.3454	0.3188,0.3453	0.3187,0.3451	0.3190,0.3455
16.0	0.3188,0.3453	0.3187,0.3451	0.3190,0.3455	0.3190,0.3456
18.0	0.3187,0.3451	0.3190,0.3455	0.3190,0.3456	0.3191,0.3458
20.0	0.3190,0.3455	0.3190,0.3456	0.3191,0.3458	0.3192,0.3461
22.0	0.3190,0.3456	0.3191,0.3458	0.3192,0.3461	0.3193,0.3462
24.0	0.3191,0.3458	0.3192,0.3461	0.3193,0.3462	0.3193,0.3462
26.0	0.3192,0.3461	0.3193,0.3462	0.3193,0.3462	0.3194,0.3464
28.0	0.3193,0.3462	0.3193,0.3462	0.3194,0.3464	0.3194,0.3465
30.0	0.3193,0.3462	0.3194,0.3464	0.3194,0.3465	0.3195,0.3467
32.0	0.3194,0.3464	0.3194,0.3465	0.3195,0.3467	0.3198,0.3470
34.0	0.3194,0.3465	0.3195,0.3467	0.3198,0.3470	0.3200,0.3473
36.0	0.3195,0.3467	0.3198,0.3470	0.3200,0.3473	0.3201,0.3475
38.0	0.3198,0.3470	0.3200,0.3473	0.3201,0.3475	0.3203,0.3478

Test Type : Type C

Test Distance : 8.160 m

C Plane (°): 0.0-180.0:1.0

 γ (°): 0.0-180.0:1.0

Test Device : Lisun LSG-1890B (E312012J)

Temperature : 25.0°C

Humidity : 65.0%

Test Lab : LISUN Lab

Test By : David

Review By :

Report No.: 4

Test Time : 2021-03-09 16:28:41

Page 25 of 29

Color Distribution Data

Color Distribution Data (x,y)

Average Color(x,y):(0.3200,0.3478)

G\C	0.0	30.0	60.0	90.0
40.0	0.3200,0.3473	0.3201,0.3475	0.3203,0.3478	0.3205,0.3480
42.0	0.3201,0.3475	0.3203,0.3478	0.3205,0.3480	0.3206,0.3483
44.0	0.3203,0.3478	0.3205,0.3480	0.3206,0.3483	0.3206,0.3489
46.0	0.3205,0.3480	0.3206,0.3483	0.3206,0.3489	0.3212,0.3493
48.0	0.3206,0.3483	0.3206,0.3489	0.3212,0.3493	0.3216,0.3498
50.0	0.3206,0.3489	0.3212,0.3493	0.3216,0.3498	0.3220,0.3504
52.0	0.3212,0.3493	0.3216,0.3498	0.3220,0.3504	0.3223,0.3510
54.0	0.3216,0.3498	0.3220,0.3504	0.3223,0.3510	0.3185,0.3446
56.0	0.3220,0.3504	0.3223,0.3510	0.3185,0.3446	0.3184,0.3445
58.0	0.3223,0.3510	0.3185,0.3446	0.3184,0.3445	0.3186,0.3446

 Test Type : Type C
 Test Device : Lisun LSG-1890B (E312012J)
 Test Lab : LISUN Lab
 Test By : David

Test Distance : 8.160 m

 C Plane (°): 0.0-180.0:1.0
 Temperature : 25.0°C

 γ (°): 0.0-180.0:1.0
 Humidity : 65.0%

Review By :

Report No. : 4

Test Time : 2021-03-09 16:28:41

Page 26 of 29

Color Distribution Data

Color Distribution Data (x,y)

Average Color(x,y):(0.3200,0.3478)

G\C	120.0	150.0	180.0	210.0
0.0	0.3188,0.3451	0.3186,0.3448	0.3187,0.3451	0.3189,0.3454
2.0	0.3186,0.3448	0.3187,0.3451	0.3189,0.3454	0.3188,0.3453
4.0	0.3187,0.3451	0.3189,0.3454	0.3188,0.3453	0.3187,0.3451
6.0	0.3189,0.3454	0.3188,0.3453	0.3187,0.3451	0.3190,0.3455
8.0	0.3188,0.3453	0.3187,0.3451	0.3190,0.3455	0.3190,0.3456
10.0	0.3187,0.3451	0.3190,0.3455	0.3190,0.3456	0.3191,0.3458
12.0	0.3190,0.3455	0.3190,0.3456	0.3191,0.3458	0.3192,0.3461
14.0	0.3190,0.3456	0.3191,0.3458	0.3192,0.3461	0.3193,0.3462
16.0	0.3191,0.3458	0.3192,0.3461	0.3193,0.3462	0.3193,0.3462
18.0	0.3192,0.3461	0.3193,0.3462	0.3193,0.3462	0.3194,0.3464
20.0	0.3193,0.3462	0.3193,0.3462	0.3194,0.3464	0.3194,0.3465
22.0	0.3193,0.3462	0.3194,0.3464	0.3194,0.3465	0.3195,0.3467
24.0	0.3194,0.3464	0.3194,0.3465	0.3195,0.3467	0.3198,0.3470
26.0	0.3194,0.3465	0.3195,0.3467	0.3198,0.3470	0.3200,0.3473
28.0	0.3195,0.3467	0.3198,0.3470	0.3200,0.3473	0.3201,0.3475
30.0	0.3198,0.3470	0.3200,0.3473	0.3201,0.3475	0.3203,0.3478
32.0	0.3200,0.3473	0.3201,0.3475	0.3203,0.3478	0.3205,0.3480
34.0	0.3201,0.3475	0.3203,0.3478	0.3205,0.3480	0.3206,0.3483
36.0	0.3203,0.3478	0.3205,0.3480	0.3206,0.3483	0.3206,0.3489
38.0	0.3205,0.3480	0.3206,0.3483	0.3206,0.3489	0.3212,0.3493

Test Type : Type C

Test Distance : 8.160 m

C Plane (°): 0.0-180.0:1.0

γ (°): 0.0-180.0:1.0

Test Device : Lisun LSG-1890B (E312012J)

Temperature : 25.0°C

Humidity : 65.0%

Test Lab : LISUN Lab

Test By : David

Review By :

Report No.: 4

Test Time : 2021-03-09 16:28:41

Page 27 of 29

Color Distribution Data

Color Distribution Data (x,y)

Average Color(x,y):(0.3200,0.3478)

G\C	120.0	150.0	180.0	210.0
40.0	0.3206,0.3483	0.3206,0.3489	0.3212,0.3493	0.3216,0.3498
42.0	0.3206,0.3489	0.3212,0.3493	0.3216,0.3498	0.3220,0.3504
44.0	0.3212,0.3493	0.3216,0.3498	0.3220,0.3504	0.3223,0.3510
46.0	0.3216,0.3498	0.3220,0.3504	0.3223,0.3510	0.3185,0.3446
48.0	0.3220,0.3504	0.3223,0.3510	0.3185,0.3446	0.3184,0.3445
50.0	0.3223,0.3510	0.3185,0.3446	0.3184,0.3445	0.3186,0.3446
52.0	0.3185,0.3446	0.3184,0.3445	0.3186,0.3446	0.3186,0.3448
54.0	0.3184,0.3445	0.3186,0.3446	0.3186,0.3448	0.3186,0.3448
56.0	0.3186,0.3446	0.3186,0.3448	0.3186,0.3448	0.3185,0.3449
58.0	0.3186,0.3448	0.3186,0.3448	0.3185,0.3449	0.3184,0.3446

 Test Type : Type C
 Test Device : Lisun LSG-1890B (E312012J)
 Test Lab : LISUN Lab
 Test By : David

Test Distance : 8.160 m

C Plane (°): 0.0-180.0:1.0

Temperature : 25.0°C

 γ (°): 0.0-180.0:1.0

Humidity : 65.0%

Review By :

Report No. : 4

Test Time : 2021-03-09 16:28:41

Page 28 of 29

Color Distribution Data

Color Distribution Data (x,y)

Average Color(x,y):(0.3200,0.3478)

G\C	240.0	270.0	300.0	330.0
0.0	0.3188,0.3453	0.3187,0.3451	0.3190,0.3455	0.3190,0.3456
2.0	0.3187,0.3451	0.3190,0.3455	0.3190,0.3456	0.3191,0.3458
4.0	0.3190,0.3455	0.3190,0.3456	0.3191,0.3458	0.3192,0.3461
6.0	0.3190,0.3456	0.3191,0.3458	0.3192,0.3461	0.3193,0.3462
8.0	0.3191,0.3458	0.3192,0.3461	0.3193,0.3462	0.3193,0.3462
10.0	0.3192,0.3461	0.3193,0.3462	0.3193,0.3462	0.3194,0.3464
12.0	0.3193,0.3462	0.3193,0.3462	0.3194,0.3464	0.3194,0.3465
14.0	0.3193,0.3462	0.3194,0.3464	0.3194,0.3465	0.3195,0.3467
16.0	0.3194,0.3464	0.3194,0.3465	0.3195,0.3467	0.3198,0.3470
18.0	0.3194,0.3465	0.3195,0.3467	0.3198,0.3470	0.3200,0.3473
20.0	0.3195,0.3467	0.3198,0.3470	0.3200,0.3473	0.3201,0.3475
22.0	0.3198,0.3470	0.3200,0.3473	0.3201,0.3475	0.3203,0.3478
24.0	0.3200,0.3473	0.3201,0.3475	0.3203,0.3478	0.3205,0.3480
26.0	0.3201,0.3475	0.3203,0.3478	0.3205,0.3480	0.3206,0.3483
28.0	0.3203,0.3478	0.3205,0.3480	0.3206,0.3483	0.3206,0.3489
30.0	0.3205,0.3480	0.3206,0.3483	0.3206,0.3489	0.3212,0.3493
32.0	0.3206,0.3483	0.3206,0.3489	0.3212,0.3493	0.3216,0.3498
34.0	0.3206,0.3489	0.3212,0.3493	0.3216,0.3498	0.3220,0.3504
36.0	0.3212,0.3493	0.3216,0.3498	0.3220,0.3504	0.3223,0.3510
38.0	0.3216,0.3498	0.3220,0.3504	0.3223,0.3510	0.3185,0.3446

Test Type : Type C

Test Distance : 8.160 m

C Plane (°): 0.0-180.0:1.0

γ (°): 0.0-180.0:1.0

Test Device : Lisun LSG-1890B (E312012J)

Temperature : 25.0°C

Humidity : 65.0%

Test Lab : LISUN Lab

Test By : David

Review By :

Report No.: 4

Test Time : 2021-03-09 16:28:41

Page 29 of 29

Color Distribution Data

Color Distribution Data (x,y)

Average Color(x,y):(0.3200,0.3478)

G\C	240.0	270.0	300.0	330.0
40.0	0.3220,0.3504	0.3223,0.3510	0.3185,0.3446	0.3184,0.3445
42.0	0.3223,0.3510	0.3185,0.3446	0.3184,0.3445	0.3186,0.3446
44.0	0.3185,0.3446	0.3184,0.3445	0.3186,0.3446	0.3186,0.3448
46.0	0.3184,0.3445	0.3186,0.3446	0.3186,0.3448	0.3186,0.3448
48.0	0.3186,0.3446	0.3186,0.3448	0.3186,0.3448	0.3185,0.3449
50.0	0.3186,0.3448	0.3186,0.3448	0.3185,0.3449	0.3184,0.3446
52.0	0.3186,0.3448	0.3185,0.3449	0.3184,0.3446	0.3186,0.3449
54.0	0.3185,0.3449	0.3184,0.3446	0.3186,0.3449	0.3186,0.3448
56.0	0.3184,0.3446	0.3186,0.3449	0.3186,0.3448	0.3185,0.3448
58.0	0.3186,0.3449	0.3186,0.3448	0.3185,0.3448	0.3185,0.3447

 Test Type : Type C
 Test Device : Lisun LSG-1890B (E312012J)
 Test Lab : LISUN Lab
 Test By : David

Test Distance : 8.160 m

 C Plane (°): 0.0-180.0:1.0
 Temperature : 25.0°C

 γ (°): 0.0-180.0:1.0
 Humidity : 65.0%

Review By :